

911 SIGNAL[®]

**VEHICLE WARNING
SYSTEM**

Your innovative and
Reliable partner

911 SIGNAL TECHNOLOGY INC.

Tel: +86-574-89017911 +86-400-6757-911

Fax: +86-574-82822560 Email: sales@911signal.com

CN-Add: Room 701-702, Hengwei Building, No.258, Tiangao Lane, Shounan Subdistrict,
Yinzhou Area, Ningbo City, Zhejiang, China

EU-Add:19 rue Pierre Curie, 92400, Courbevoie,FRANCE

Email: euoffice@911signalgroup.com

Tel: +33(0)659163209

www.911signal.com

911 SIGNAL[®]

911 SIGNAL TECHNOLOGY INC.



911 Signal
Vehicle Warning System



WHAT WE DO

Originated in 1998, 911 Signal has been dedicated to serving customers globally with excellent-quality emergency vehicle warning solutions and control systems. 911 Signal is a successively growing company located in Ningbo China and is well on the way of becoming the most professional and innovative supplier in the industry. With a grand opening of the office and investment on the warehouse in Paris France, we now have a even more extensive network of distributors and partners in Europe, America, Africa, Asia and Australasia.

Our Vision

We will be our customer's first choice, today and tomorrow.

Our Mission

Grow into a time-honored company. Offer our customers with the indispensable safety warning products within the sectors of automotive, aviation, maritime, and outdoor.

Core Value

Be the top and only chosen attempt at success.



Jack Yu

Jack YU
CEO

TECHNOLOGY YOU CAN RELY ON

Your innovative and Reliable partner

69K

Waterproof testing

24

24 Hours of Rain for Most Products

70

70°C During Temperature Testing

Our testing processes allow us to fully comply with and exceed CE, SAE, California Title 13 and ECE regulations including ECE Regulation, 10,48 and 65, as well as SAE J595 and J845 standards.

To maintain our conformity of production, samples are regularly subjected to harsh environmental testing and subjected to other destructive and non-destructive testing to consistently guarantee high-quality products.

we are constantly upgrading to the latest in CNC, SMT, injection moulding and other production technologies, as well as investing in our in-house testing laboratory. Every single product you buy from 911 Signal is subject to quality tests following each step of manufacturing process.

Arduous and strict quality control measures are implemented from the minute raw materials arrive at 911 factory to the moment packaged products leave the plant.



Photometric Test



Dust Test



Immersion and pressure Tightness Test



Heat, Moisture and Cold Test



Splash Water Test



Pressurized Water Test

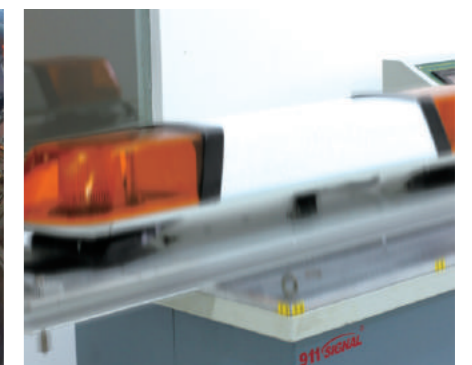

Vibration Test

OUR PASSION MAKES US UNIQUE

From our home and extensive manufacturing and testing facilities in Ningbo, and offices in Europe to partner facilities in the United States-our impressive reach and product portfolio is accompanied by know LED geable staff, responsive service and the highest standards of customer care.



Serious as regards to the establishment and development of business relationships that truly are mutually-beneficial.

Our partners and consultants in the Netherlands, the United Kingdom and the United States work hand-in-hand with us by undertaking independent market research, and by assisting us in product design and manufacturing research to ensure we are highly responsive to our consumers` needs.

DRIVEN BY ETHICES NOT JUST AMBITION

Our customer service staff offers frank, responsible and efficient communication with clients. Every piece of information regarding lead time, order status, or delivery time is announced with accuracy, completeness and faithfulness.





**WHERE
TO MEET
US?**

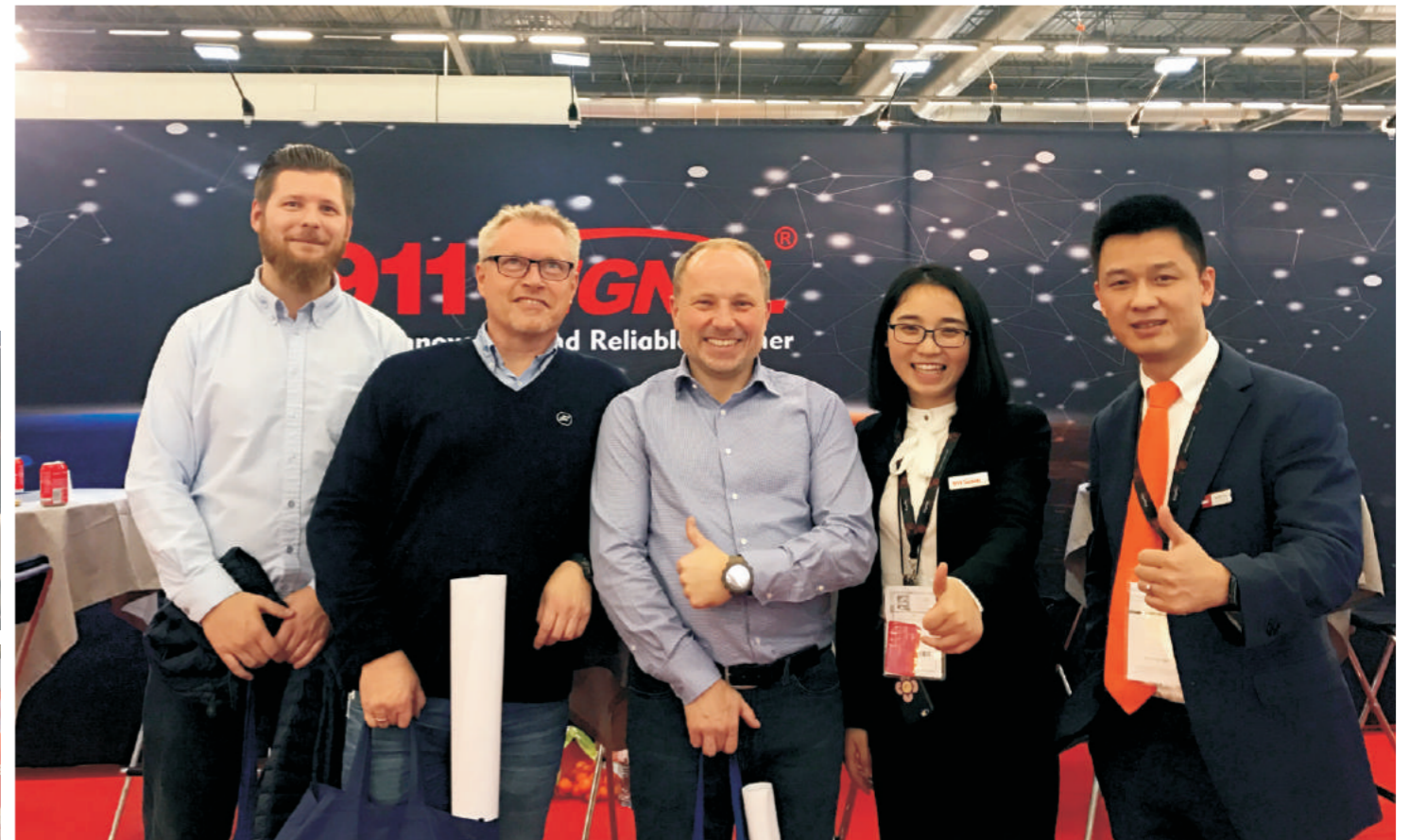

Each year the 911 team travels to exhibit in major trade shows including but not confined to IACP, APPEX, MILIPOL, RETT, Automechanika. We follow market trends closely and visit clients to get first hand feedback. Combining comprehensive marketing research, customer requirements and feedback, we form the idea of a new product or update on existing products.

TABLE OF CONTENTS



LED LIGHTBAR

03	INTELCOMM	NEW
05	LURKER	NEW
06	INSTRUCTOR	
07	ADVENTURER	
11	SKYLINE AIR	
12	SKYLINE	
15	F117E3	
19	WARRIOR	
20	MINI WARRIOR	
21	MINI ADVENTURER	
23	RAPTOR-33T	
24	O3	
24	O4	

LIGHTHEADS

25	PANORAMA	NEW
26	STARK O	NEW
27	NR6/NR6T	NEW
28	FIN6	NEW
29	F6	
30	F3	
31	X6/X6T	
33	X8/X8T	NEW
34	X9/ X9T/X18	
35	L200/L200T	
36	C9/C9T	NEW
37	T4/T8	
38	C4/C4-D	
39	H3/H4/H4S1	
40	H6/HL6/E3	
41	E24/E4/E36	
42	A4	
43	P3/P3 PRO	
44	PAR36	

HIDEAWAY LIGHTS

45	ANT PRO	
45	ANT6	
46	H1200	NEW
46	N500	
46	H2100	

LED BEACONS

49	FD24	
49	FD24 MINI	
50	C12 MAG	NEW
51	SPOT	
51	CONDUCTOR	
53	C24	
53	C24-E	
54	C12	
54	F66/F105	NEW

LED STICK LIGHTS

57	C4-S SERIES	
59	PIONEER	
60	HORNET	

LED VISOR LIGHTS

61	LUMIOPT	NEW
62	C40	
62	LV100	
63	H2	
63	EG4	
64	WITEL	

SIREN

66	SR-100AD/SR-100RD	
69	IW1/IW2	
70	IW3	
70	IWR: IW3+	

SPEAKER

73	H100	74	S100-1
73	H200	74	S80-1
73	S100-3	74	S80-3
74	S100-3A		

ACCESSORIES

SWITCH

75	BR9000
76	FLOW
76	BR8
77	BR990
77	BR993
77	BR930
78	BR100
78	BR960
78	BR920

CIGAR PLUGS

79	A13-163
79	A13-54
79	A13-53
79	A13-76
79	A13-102
79	A13-E163

81 BRACKETS

82	FOR BEACONS
82	GUTTERS



reddot award 2016
winner



LED LIGHTBAR

iF Design Award winning 'Intelcomm' lightbar perfectly fulfills the needs of the high end requirements of the emergency services in terms of design, appearance and functionality.

The 'Intelcomm' meets and exceeds all regulatory requirements including SAE, CA T13, ECE R65 and ECE R10. Additionally the bar is protected to IP68, together with its reinforced and optimized structure.

Warning System Solution

911 SIGNAL[®]



 INTELCOMM

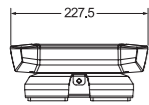
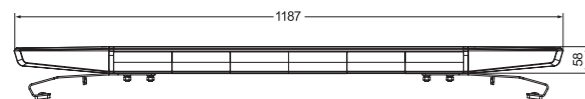

FEATURES

- With rich module options including daytime running light, brake light, turn light, spotlight and traffic adviser, Intelcomm enhances your ability to communicate with your surroundings
- Ready to be customized to meet your special requirements
- Available in single, dual and triple color models
- Showcase of the best craftsmanship in the industry with the diamond cut technique and minimalism design
- Automatically or manually adjustable high/low power light modes ensures a safe journey from beginning to end
- IP 68 rated; fully encapsulated for moisture, vibration and corrosion resistance
- Hard-coated lenses and aluminum housing minimize environmental damage

Item	Length	LED	Max Power	Voltage	Flash Patterns	Operating Temperature	Mount	Certification
012002	48"	148pcs	210W	DC 10-33V	29	-30 to +70°C	Gutter Mount, Direct/Bolt Mount, Roof Rail Mount	SAE CA Title 13 ECE R65 TA2 TB2 ECE R10
012003	56"	184pcs	/					



PRODUCT DESCRIPTION

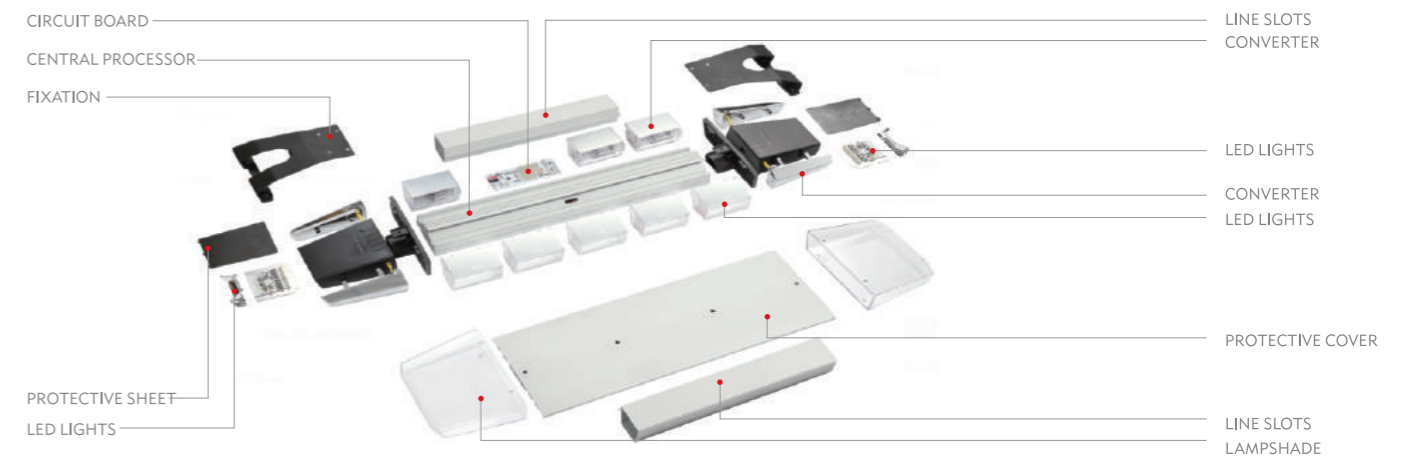

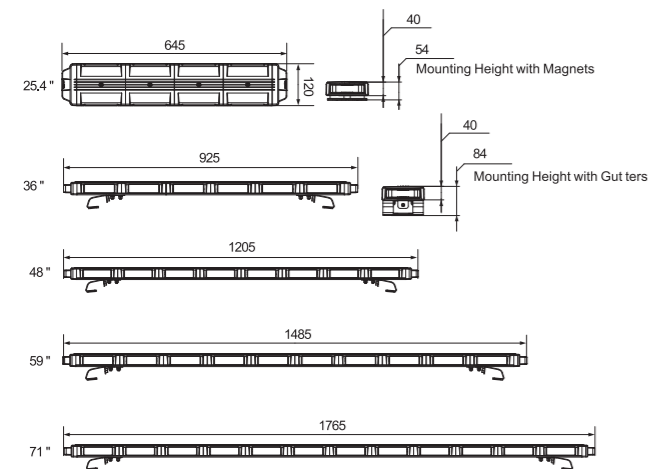

FEATURES

- Easy module replacement
- Modern and compact design
- Choose from smoked or silver housing
- Full encapsulated for moisture, vibration and corrosion resistance
- Excellent water resistance with waterproof modules and socket connectors
- Hard-coated lenses and aluminum housing minimize environmental damage
- Different lengths to choose from: 26", 36", 48", 59", 71"

Item	Length	LED	Max Power	Voltage	Flash Patterns	Operating Temperature	Mount	Certification
013501	25.4"	42pcs	75W	DC 10-33V	28	-30 to +70°C	Magnetic Mount	SAE ECE R10 ECE R65 TA2 Tb2
013541	48"	66pcs	120W				Gutter Mount Direct/Bolt Mount Roof Rail Mount	

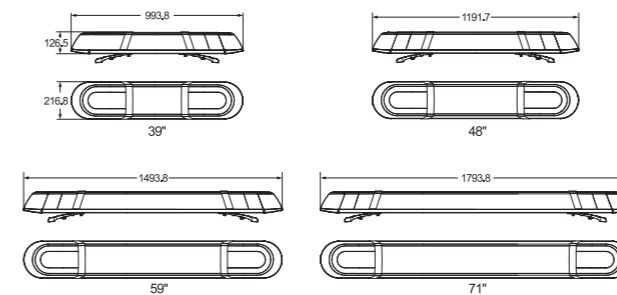

FEATURES

- Easy installation by simply connecting the two wires to power supply
- Four kinds of beacons to choose from: Spot, C12, C24 and FD24 Mini
- Best value for money with guaranteed quality
- Ip67 rated beacons are used at both sides. Silicone seal is not only applied between the top housing and base but also between the chambers, making the product fully encapsulated for moisture, vibration and corrosion resistance
- Awesome heat dissipation: aluminum alloy is used to direct the heat from the beacon to the base, making sure the whole product will not be over-heated
- Tough outer dome minimizes environmental damage

Item	Length	LED	Max Power	Voltage	Flash Patterns	Operating Temperature	Mount	Certification
012401	48"	w/ C12	48pcs	/	DC 10-33V	-30 to +70°C	Gutter Mount Direct/Bolt Mount	ECE R65 TA1 TB1 ECE R10
012410		w/ C24	96pcs					
012420		w/ Spot	24pcs					
012431		w/ FD24 Mini	24pcs					

ADVENTURER

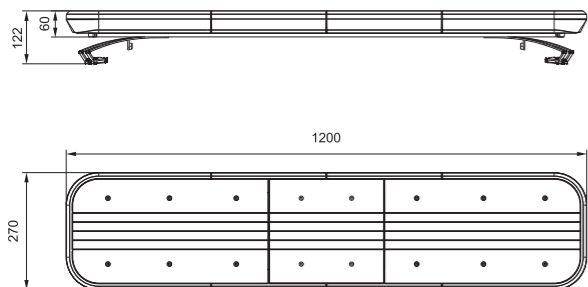
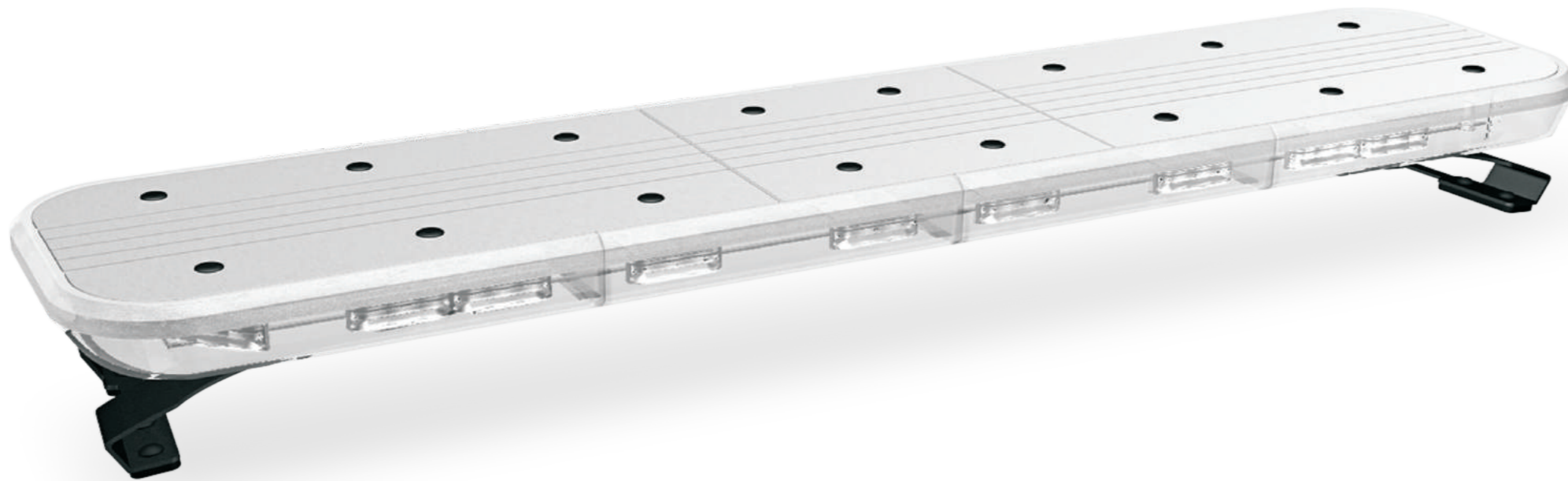

FEATURES

- Unique and beautiful design
- Advanced thermal design reduces the stress on LEDs during extended dwell time
- Upgraded reflectors enhance optical performance
- Robust and solid aluminum dome and hard-coated lenses minimize environmental damage
- Fully encapsulated for moisture, vibration and corrosion resistance

Item	Length	LED	Max Power	Voltage	Flash Patterns	Operating Temperature	Mount	Certification
013001	48"	60pcs	130W	DC 10-33V	33	-30 to +70°C	Gutter Mount, Direct/Bolt Mount, Roof Rail Mount	SAE Class 1 CA Title 13 ECE R65 TA2 TB2 ECE R10

Warning System Solution

911 SIGNAL[®]



LED LIGHTBAR

it is ready to face any harsh conditions that
might come on its way.

SKYLINE

SKYLINE AIR



SKYLINE



FEATURES

- Sleek, low profile and aerodynamic design makes the product the thinnest and lightest LED lightbar on the market
- Ready to be customized in lengths and functions to satisfy your needs
- Upgraded PC material minimizes environmental damage and provides sufficient heat dissipation
- Each module is given its own plastic housing, increasing flexibility of use and assembly without sacrificing either performance or reliability
- Clear and other color options available for outer lenses
- Ip68 rated; fully encapsulated for moisture, vibration and corrosion resistance

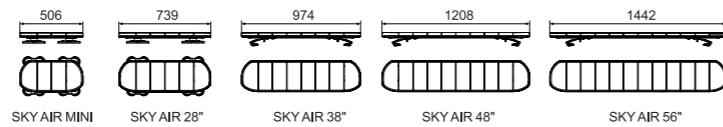

Item	Length	LED	Max Power	Voltage	Flash Patterns	Operating Temperature	Mount	Certification
011843	48"	C3 Modules	66pcs 3W	114W	29	-30 to +70°C	Gutter Mount, Direct/Bolt Mount, Roof Rail Mount	ECE R65 TA2, Tb2, TR2 ECE R10
011830		C4 modules	88pcs 3W	222W				

FEATURES

- Sleek, low profile and aerodynamic design makes the product the thinnest and lightest LED lightbar on the market
- Ready to be customized in lengths and functions to satisfy your needs
- Upgraded PC material minimizes environmental damage and provides sufficient heat dissipation
- Each module is given its own plastic housing, increasing flexibility of use and assembly without sacrificing either performance or reliability
- Clear and other color options available for outer lenses
- Ip68 rated; fully encapsulated for moisture, vibration and corrosion resistance

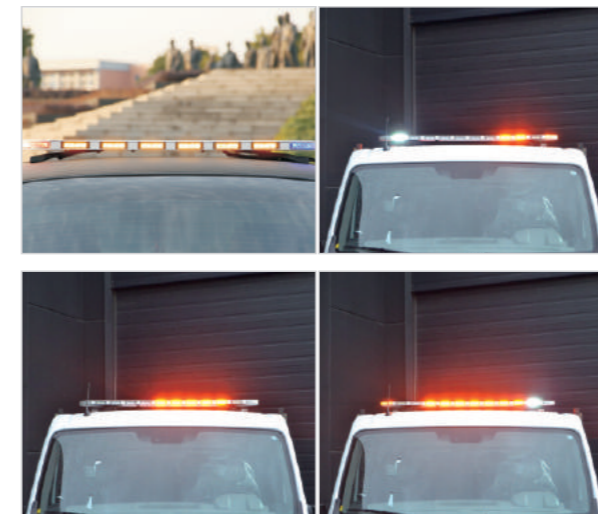
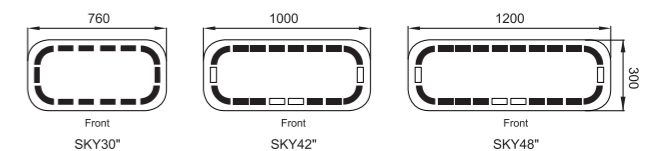

Item	Length	LED	Max Power	Voltage	Flash Patterns	Operating Temperature	Mount	Certification
011301	30"	76pcs	140W	DC 10-33V	35	-30 to +70°C	Magnetic Mount	SAE Class 1 ECE R65 TA2 TB2 ECE R10
010101	42"	92pcs	177W				Gutter Mount	
010201	48"	108pcs	222W					



LED LIGHTBAR

F117E3

Sleek, bright and super-thin (approximately the diameter of a coin!), these lightweighted LED Lightbars are 911Signal's latest high-quality offerings.

ECE-R-65 & R10 certified and exceeding all strict industry requirements, our high-intensity emergency warning lights are water-proof, vibration-resistant and even dust-proof to ensure their outstanding performance under severe environments.

F117E3

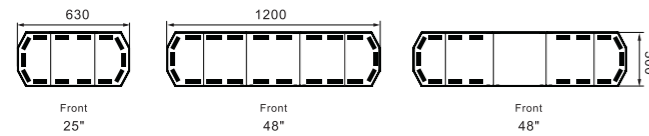

FEATURES

- Sleek, low profile and aerodynamic design makes the product the thinnest and lightest LED lightbar on the market
- Ready to be customized in lengths and functions to satisfy your needs
- Upgraded PC material minimizes environmental damage and provides sufficient heat dissipation
- Each module is given its own plastic housing, increasing flexibility of use and assembly without sacrificing either performance or reliability
- Clear and other color options available for outer lenses
- Ip68 rated; fully encapsulated for moisture, vibration and corrosion resistance

Item	Length	LED	Max Power	Voltage	Flash Patterns	Operating Temperature	Mount	Certification
010901	25"	42pcs	98W	DC 10-33V	35	-30 to +70°C	Magnetic Mount	ECE R65 TA2 TB1 ECE R10
010401	48"	66pcs	154W				Gutter Mount	
010501		w/ speaker	54pcs					

Warning System Solution

911 SIGNAL[®]

LED LIGHTBAR

WARRIOR[™]



WARRIOR™

MINI WARRIOR™

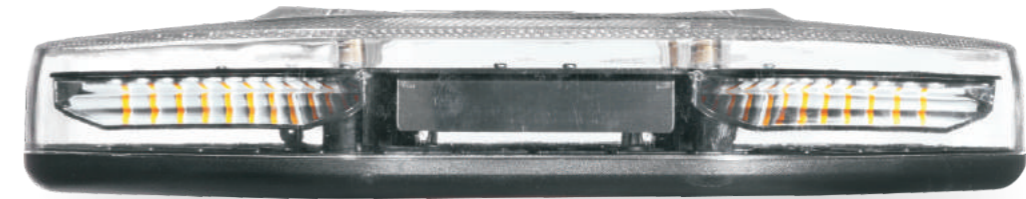
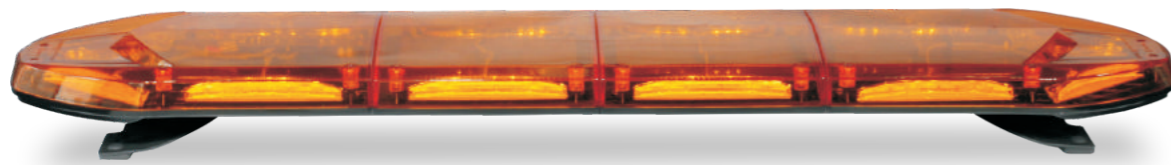

FEATURES

- Perfect choice for amber market
- Four length configurations to choose from
- Fast and easy installation
- Upgraded PC material minimizes environmental damage and provides sufficient heat dissipation
- Ip67 rated; fully sealed and waterproof

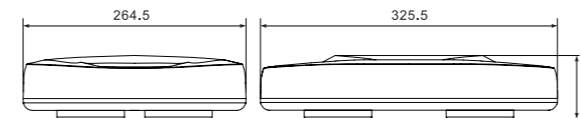
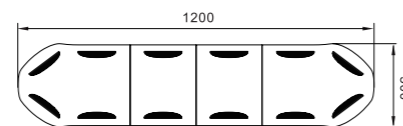

FEATURES

- 360° visibility
- Available in amber, blue and red/blue combinations
- Magnetic mount, bracket mount or two bolts mount
- Easy connection to vehicles through a cigarette plug
- Extruded aluminum platform for long life dependability
- Tough and solid outer dome and lower cover minimize environmental damage
- Fully sealed and sufficient waterproof capability

Item	Length	LED	Max Power	Voltage	Flash Patterns	Operating Temperature	Mount	Certification
011602	30"	64pcs	94W	DC 10-33V	34	-30 to +70°C	Gutter Mount with brackets	ECE R65 TA1 ECE R10
011601	48"	96pcs	142W					
011603	56"	112pcs	165W					

Item	Length	LED	Max Power	Voltage	Flash Patterns	Operating Temperature	Mount	Certification
011901	14"	32pcs	48W	DC 10-33V	19	-30 to +70°C	Magnetic Mount, Two Bolts Mount	ECE R65 TA1 ECE R10

Your innovative and
Reliable partner

MINI ADVENTURER

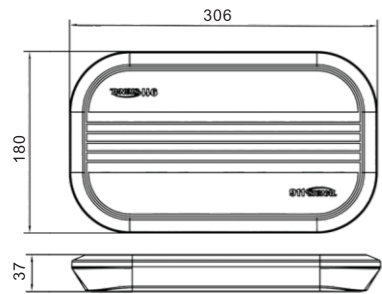

FEATURES

- Budget-friendly
- Unique and beautiful design
- Advanced thermal design reduces the stress on LEDs during extended dwell time
- Robust and solid aluminum dome and hard-coated lenses minimize environmental damage
- Fully encapsulated for moisture, vibration and corrosion resistance

Item	Length	LED	Max Power	Voltage	Flash Patterns	Operating Temperature	Mount	Certification
013101	12"	30pcs	65W	DC 10-33V	33	-30 to +70°C	Magnetic Mount	ECE R65 TA2 TB2 ECE R10

Warning System Solution



LED LIGHTBAR

RAPTOR-33T



RAPTOR-33T



FEATURES

- Unique diamond shape
- Tough polycarbonate housing and hard-coated lenses and minimize environmental damage
- Cigarette plug with on/off and flash pattern switch
- Medium-sized mini lightbar with high intensity light output and 360° coverage
- Easy mount with magnets
- Synchronize with other 911Signal products

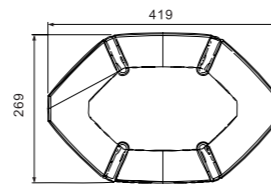

FEATURES

- A mini lightbar with high performance at an affordable price
- Low profile with a robust structure and an artistic look
- Cigarette plug with on/off and flash pattern switch
- Fast and easy mounting with strong magnets
- Fully encapsulated for moisture, vibration and corrosion resistance
- Hard-coated lenses minimize environmental damage

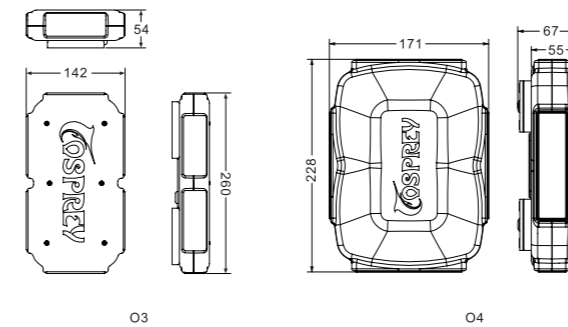

Item	Length	LED	Max Power	Voltage	Flash Patterns	Operating Temperature	Mount	Certification
011901	14"	32pcs	48W	DC 10-33V	19	-30 to +70°C	Magnetic Mount, Two Bolts Mount	ECE R65 TA1 ECE R10

Item	Length	LED	Max Power	Voltage	Flash Patterns	Operating Temperature	Mount	Certification
011101	O3	10"	18pcs	42W	DC 10-33V	19	-30 to +70°C	Magnetic Mount
011201	O4	8.8"	16pcs					

PANORAMA

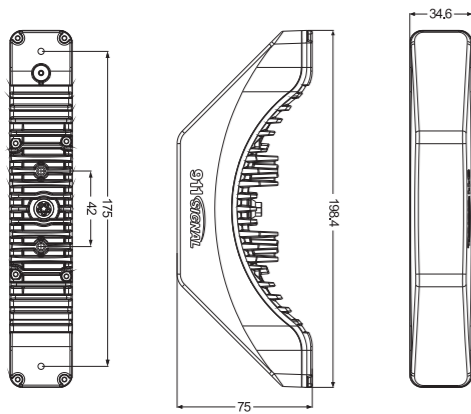
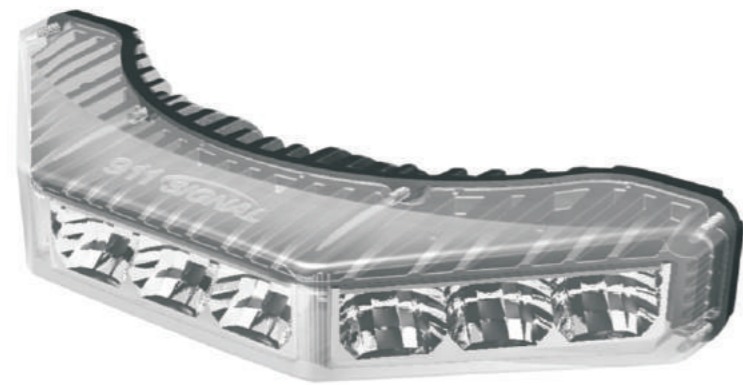

FEATURES

- Exceptionally wide spread of light: over 150° with single product, over 270° warning coverage with a pair in the front or rear and a full 360° with one module on each corner of the vehicle
- Available in single or dual colors
- Integrated 50% dim mode capability
- Aluminum die-casting base provides excellent heat dissipation
- Supplied with an adjustable bracket, making the product extremely versatile
- IP67 rated; fully encapsulated for moisture, vibration and corrosion resistance

Model	Item	LED	Max Power	Voltage	Flash Patterns	Lens	Operating Temperature	Mount	Certification
PANORAMA	022901	9pcs 3W	10W	DC 10-33V	12	Reflector	-30 to +70°C	Surface Mount Bracket Mount	SAE CA Title 13 ECE R65 ECE R10
	023001	18pcs 3W	12W						
	022903	9pcs 3W	16W	DC 10-80V					

STARK O



4"*3"

7"*3"

6"*4"

9"*7"

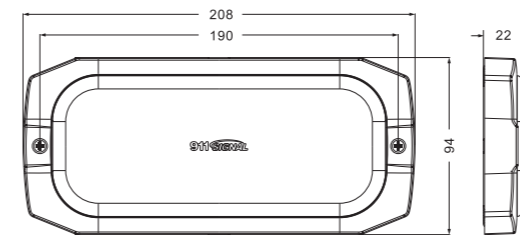

FEATURES

- Multi-functional with warning light, work light and STT
- Available in single, split, dual colors
- Provides 180 degree light spread
- Excellent heat dissipation prolongs lifespan

Model	Item	LED	Max Power	Voltage	Flash Patterns	Lens	Operating Temperature	Mount	Certification
STARK O 7"*3"	023401	12pcs 3W	20W	DC 10-33V	96	TIR	-30 to +70°C	Surface Mount	SAE, CA T13 R65, R10 NFPA and KKK certified
	023402	24pcs 3W							

NR6 / NR6T

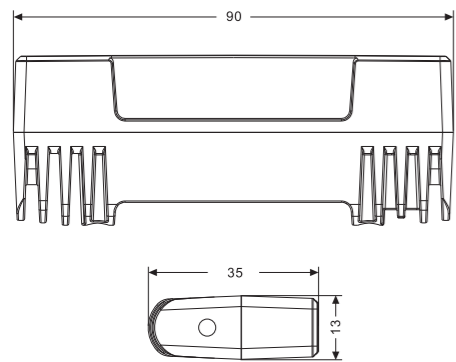
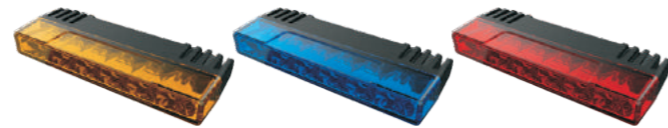

FEATURES

- Ultra low profile, suitable for tight spaces like front grills
- Control board and LED panel integrated in the chassis, making the product extremely compact
- Two universal brackets included for easy installation
- Fine heat dissipation with aluminum base
- PMMA lens minimizes UV damage and resists scratches
- SAE J595, CA T13, ECE R65 Class2 and R10 certified
- Five year warranty

Model	Item	LED	Max Power	Voltage	Flash Patterns	Lens	Operating Temperature	Mount	Certification
NR6	023302	6pcs 3W	10W	DC 10-33V	19	Clear Lens	-30 to +70°C	Bracket Mount or 3M Adhesive	SAE J595, CA T13 ECE R65 Class2 R10
NR6T	023301	12 Pcs 3W			12				

FIN6

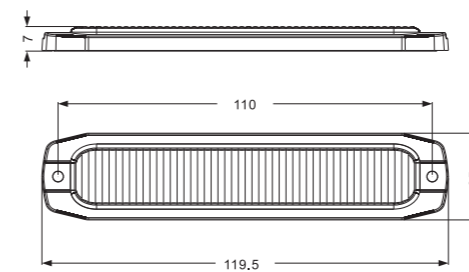
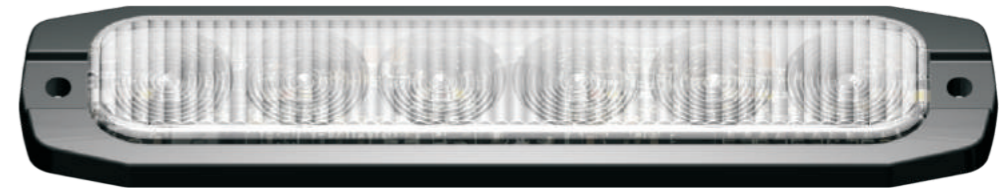

FEATURES

- Available in single or triple colors
- Ultra-thin but well layered design, excellent in texture
- Bolt mount or adhesive mount
- DKM bi-injection technology

Model	Item	LED	Max Power	Voltage	Flash Patterns	Lens	Operating Temperature	Mount	Certification
FIN6	022701	6pcs 3W	10W	DC 10-33V	19	Fresnel	-30 to +70°C	Bolt Mount Adhesive Mount	SAE CA Title 13 ECE R65 ECE R10
		18pcs 3W			12				

F6

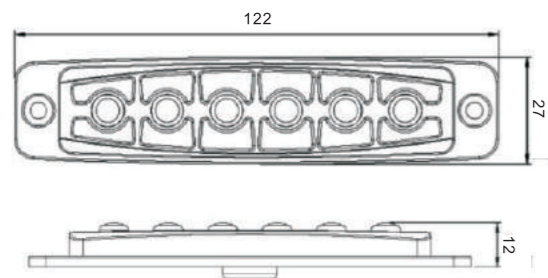

FEATURES

- Low profile with a robust structure and an artistic look
- Can be horizontally or vertically mounted
- Optional flange or stainless steel bezel available for surface mounting
- Available in single or split color

Model	Item	LED	Max Power	Voltage	Flash Patterns	Lens	Operating Temperature	Mount	Certification
F6	021301	6Pcs 3W	18W	DC 10-33V	19	TIR	-30 to +70°C	Surface Mount, Bracket Mount	SAE Class 1 CA Title 13 ECE R65 XA1 XB1 ECE R10
	021302								

F3

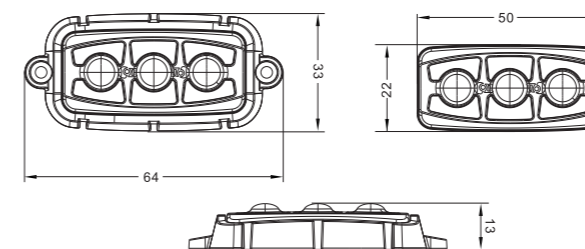

FEATURES

- Ultra thin, compact but powerful
- Can be applied to any desired surface with brackets or 3M adhesive
- Full encapsulated for moisture, vibration and corrosion resistance
- Hard-coated lenses and aluminum housing minimize environmental damage
- Synchronize to other 911Signal products

Model	Item	LED	Max Power	Voltage	Flash Patterns	Lens	Operating Temperature	Mount	Certification
F3	021201	3Pcs 3W	5W	DC 10-33V	13	TIR	-30 to +70°C	3M Adhesive Mount, Surface Mount, Bracket Mount	ECE R10

Your innovative and
Reliable partner

Warning System Solution

911 SIGNAL

X6 / X6T

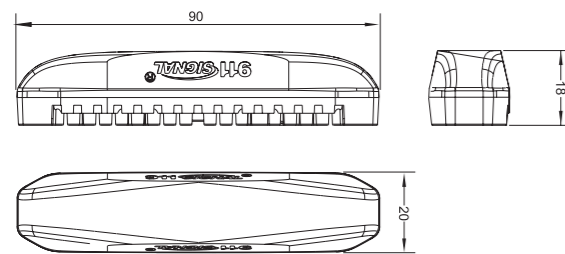

FEATURES

- Available in single, split, dual colors
- Sufficient heat dissipation prolongs lifespan
- Wide light spread, reaching 180°
- Perfect combination of work and warning light
- Clear or smoked lenses are available
- Securely mounted with surface mount or bracket mount
- Full encapsulated for moisture, vibration and corrosion resistance
- Hard-coated lenses and aluminum housing minimize environmental damage
- Synchronize to other 911Signal products



Model	Item	LED	Max Power	Voltage	Flash Patterns	Lens	Operating Temperature	Mount	Certification
X6	021101	6pcs 3W	13W	DC 10-33V	19	TIR	-30 to +70°C	Surface Mount, Bracket Mount	SAE Class 1 CA Title 13 ECE R65 XA1 XB1 ECE R10
X6T	021110	12pcs 3W	11W		12				

X8/X8T

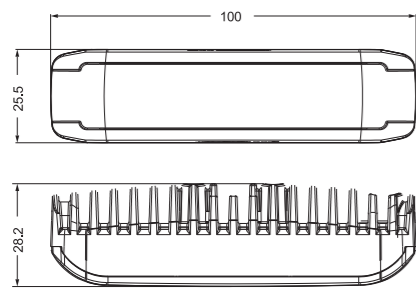

FEATURES

- 180° wide-angle illumination
- Available in single, dual and triple colors
- Includes steady-burn, alternating and simultaneous patterns
- Mount with bracket, 3M adhesive or bolts, suitable for numerous applications
- Synchronize with up to 12 911 Signal products
- Hard-coated lenses and aluminum housing minimize environmental damage

Model	Item	LED	Max Power	Voltage	Flash Patterns	Lens	Operating Temperature	Mount	Certification
X8	022501	8Pcs 3W	12 W	DC 10-33V	19	FLARE	-30 to +70°C	Surface Mount, Bracket Mount	SAE Class 1 CA Title 13 ECE R65 XA2 XB2 XR2 ECE R10
X8T	022603	16Pcs 3W			12				
		24Pcs 3W							

X9/ X9T

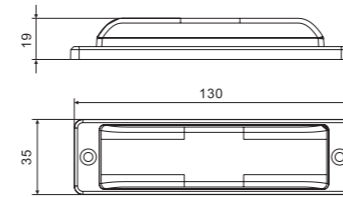

X18

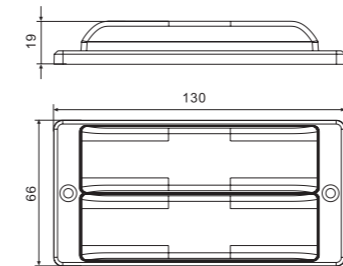

FEATURES

- 180° wide-angle coverage
- Aluminum base efficiently dissipates heat
- Surface mount or bracket mount, suitable for numerous applications
- Fully encapsulated for moisture, vibration and corrosion resistance
- Hard-coated lenses and aluminum housing minimize environmental damage
- Synchronize with other 911 Signal products

X9

- Available in single or split color
- Optional cover available

X9T

- Available in dual or triple colors

X18

- Available in single color

Model	Item	LED	Max Power	Voltage	Flash Patterns	Lens	Operating Temperature	Mount	Certification
X9	021801	9pcs 3W	22W	DC 10-33V	19	LIN	-30 to +70°C	Surface Mount, Bracket Mount	SAE J595 class2 CA T13 ECE R65 ECE R10
X9T	021802	18pcs 3W	24W		47				
X18	021803		44W		12				

Your innovative and
Reliable partner

L200/L200T

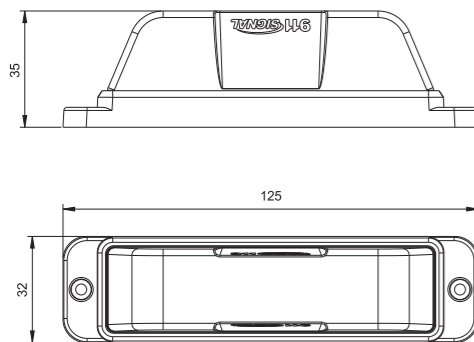

FEATURES

- As the name suggests, it offers 200° high intensity light coverage
- Available in single, dual and triple colors
- Perfect combination of work light and warning light
- Includes steady-burn, simultaneous and alternating flash patterns
- Low power consumption, especially for night time use
- Fully encapsulated for moisture, vibration and corrosion resistance
- Can be synchronized with multiple units

Model	Item	LED	Max Power	Voltage	Flash Patterns	Lens	Operating Temperature	Mount	Certification
L200/L200T	022203	10pcs 3W+2pcs 2W	22W	DC 10-33V	19	FLARE	-30 to +70°C	Surface Mount	SAE Class 1 CA Title 13 ECE R65 ECE R10
		18pcs 3W+2pcs 2W	12W		12				
		27pcs 3W+2pcs 2W	12W		12				



C9/C9T



FEATURES

- All time best seller
- Eyebrows protect the lighthead against impacts and scratches
- Available in single, dual and triple colors
- Super wide light angle
- Fully encapsulated for moisture, vibration and corrosion resistance
- Aluminum housing offers the best protection and heat dissipation

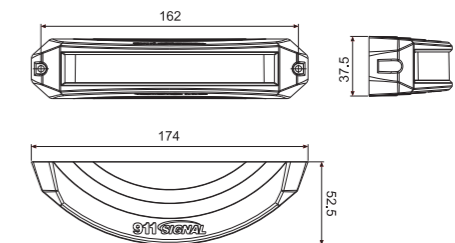

Model	Item	LED	Max Power	Voltage	Flash Patterns	Lens	Operating Temperature	Mount	Certification
C9	020104	9pcs 3W	13W	DC 10-33V	19	REFLEX	-30 to +70°C	Surface Mount	ECE R65 XA1 ECE R10
C9T	023101	18pcs 3W	15W		12				
	023102	27pcs 3W							

FEATURES

- Modern and beautiful look
- Super high intensity output in remarkably compact and low-profile design
- Available in single or split color
- Includes steady-burn, simultaneous and alternating flash patterns
- Fully encapsulated for moisture, vibration and corrosion resistance
- Low power consumption, especially for night time use

FEATURES

- Strong off-axis light output
- Available in single and split color
- Easy installation with brackets or screws
- Low profile with a height of only 1"
- Fully encapsulated for moisture, vibration and corrosion resistance
- Aluminum base offers the best protection and heat dissipation
- Synchronize to other 911Signal products

T4

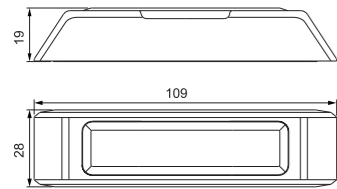

C4

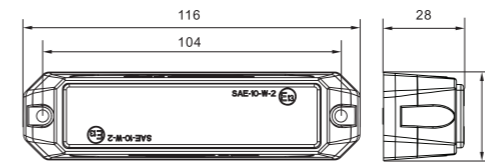

T8

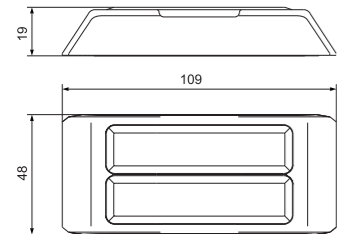

C4-D

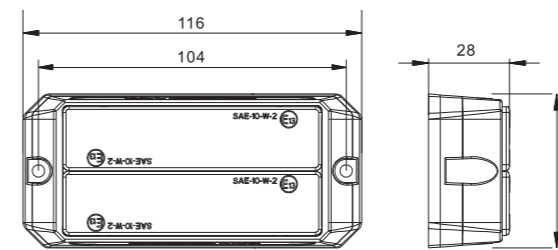

Model	Item	LED	Max Power	Voltage	Flash Patterns	Lens	Operating Temperature	Mount	Certification
T4	021601	4Pcs 3W	12W	DC 10-33V	19	TIR	-30 to +70°C	Surface Mount, Bracket Mount	SAE J595 Class 1 CA Title 13 ECE R65 XA1 XB1 XR1 ECE R10
T8	021701	8Pcs 3W	24W						

Model	Item	LED	Max Power	Voltage	Flash Patterns	Lens	Operating Temperature	Mount	Certification
C4	020101	4Pcs 3W	9W	DC 10-33V	19	REFLEX	-30 to +70°C	Surface Mount	SAE Class 1 ECE R65 XA1 XB1 ECE R10
C4-D	020103	8Pcs 3W	19W						

H3

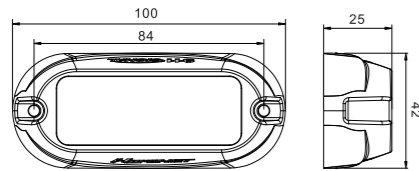

H4

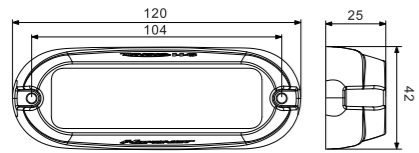

H4S1

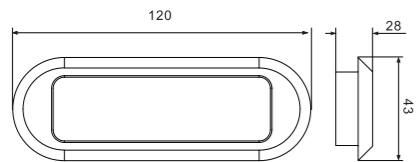

HL6

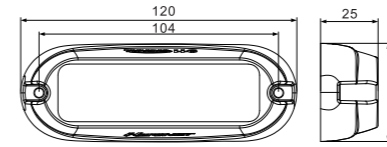

H6

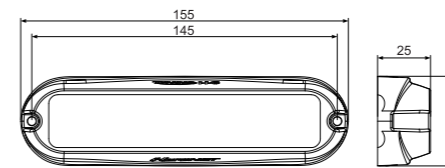

E3

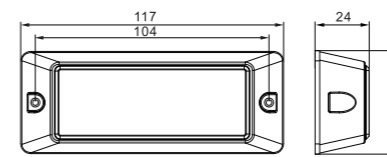

FEATURES

- Available in single color
- High performance with a reasonable price
- Thin and light, ideal for numerous applications
- Colored light sources with special optics offer excellent warning and signaling effect
- Durable and reliable with a lifespan of 100,000 hours
- Synchronization capability

Model	Item	LED	Max Power	Voltage	Flash Patterns	Lens	Operating Temperature	Mount	Certification
H3	020301	3pcs 3W	6W	DC 10-33V	19	TIR	-30 to +70°C	Surface Mount	ECE R10
H4	020302	4pcs 3W	9W						ECE R65 XB1 ECE R10
H4S1	020402							Flush Mount	

FEATURES

- Tiny and can be mounted in numerous locations
- Built from durable aluminum and polycarbonate, it is not only powerful, but rugged and water resistant
- Available in single color
- High performance with a reasonable price

Model	Item	LED	Max Power	Voltage	Flash Patterns	Lens	Operating Temperature	Mount	Certification
H6	020303	6pcs 3W	8W	DC 10-33V	19	LIN	-30 to +70°C	Surface Mount	ECE R10
HL6	020304		13W			TIR			
E3	020201	3pcs 3W	10W						

E24

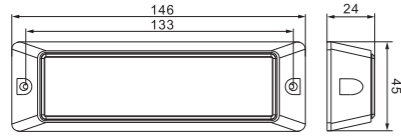

E4

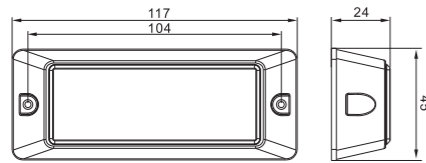

E36

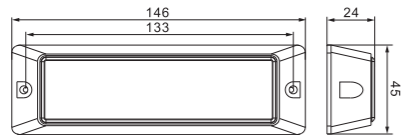

A4



FEATURES

- Available in single color
- Compact design
- Fully encapsulated for moisture, vibration and corrosion resistance

Model	Item	LED	Max Power	Voltage	Flash Patterns	Lens	Operating Temperature	Mount	Certification
E4	020202	4pcs 3W	11W	DC 12-24V	19	TIR	-30 to +70°C	Surface Mount	SAE, ECE R65, ECE R10
E24	020203	24pcs 0.2W	5W			/			/
E36	020204	36pcs 0.2W	7W			/			/

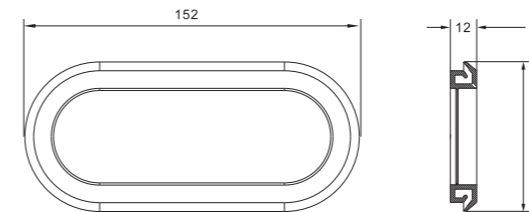

FEATURES

- Thin, light and bright
- Covers are available in multiple colors
- Durable with a lifespan over 10,000 hours

Model	Item	LED	Max Power	Voltage	Flash Patterns	Lens	Operating Temperature	Mount	Certification
A4	020401	4pcs 3W	9W	DC 10-33V	19	TIR	-30 to +70°C	Flush Mount	/

P3



FEATURES

- High intensity spotlight for commercial vehicle and public safety use
- Light and compact, suitable for any desired place
- Tough PC lens minimizes UV damage and resists scratches
- Aluminum chassis offers fine heat dissipation and prolongs lifespan
- Fully encapsulated for moisture, vibration and corrosion resistance

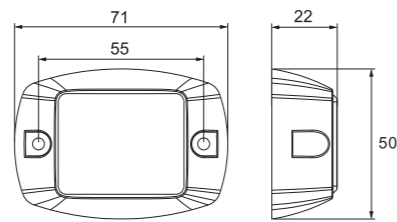

P3 PRO



FEATURES

- Durable PMMA lens minimizes UV damage and resists scratches
- Aluminum chassis offers fine heat dissipation and prolongs lifespan
- IP 67 rated; fully encapsulated for dust and moisture resistance
- Synchronize to other 911Signal products

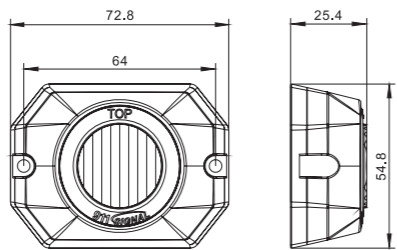

Model	Item	LED	Max Power	Voltage	Flash Patterns	Lens	Operating Temperature	Mount	Certification
P3	020501	3pcs 3W	7W	DC 10-33V	19	TIR	-30 to +70°C	Surface Mount, Bracket Mount	ECE R10
P3 PRO	021401		9W		13				ECE R65 XA1 XB1

PAR36



PT7



PTT40



PL10

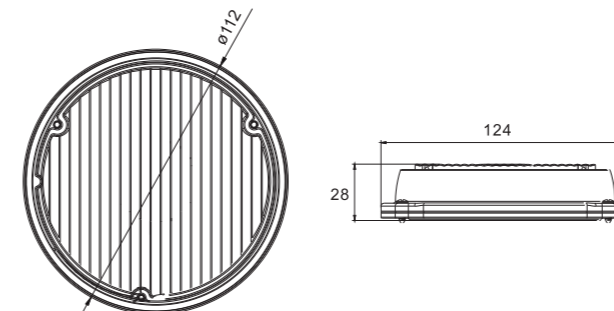

FEATURES

- Available in 3 types: PT7, PTT40 and PL10
- Tough PC lens minimizes UV damage and resists scratches
- Aluminum chassis offers fine heat dissipation and prolongs lifespan
- Easy installation with surface mount or bracket mount
- Optional chrome or black bezel
- Fully encapsulated for moisture, vibration and corrosion resistance

Model	Item	LED	Max Power	Voltage	Flash Patterns	Lens	Operating Temperature	Mount	Certification
PAR36-PT7	020601	7pcs 3W	18W	DC 10-33V	19	/	-30 to +70°C	Surface Mount, Bracket Mount	ECE R10
PAR36-PTT40	020602	40pcs 0.2W	8W						
PAR36-PL10	020603	10pcs 3W	28W			LIN			

ANT PRO



FEATURES

- One piece design that integrates flash control modules
- Durable PMMA lens minimizes environmental damage
- Aluminum chassis allows effective heat dissipation and prolongs lifespan
- IP 67 rated; fully encapsulated for moisture, vibration and corrosion resistance
- L-shaped bracket available for secure mount

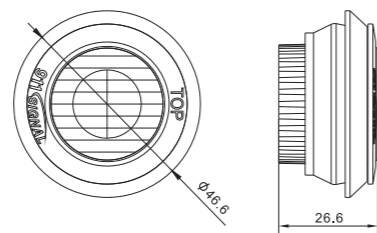

ANT6



ANT6-3

ANT6-6

FEATURES

- Small and light-weighted, suitable for any surface and even inside the headlights of a vehicle
- IP 67 rated; fully encapsulated for moisture, vibration and corrosion resistance
- Thermal dissipation is optimized through the use of an advanced heat management system, silicone, and an aluminum base

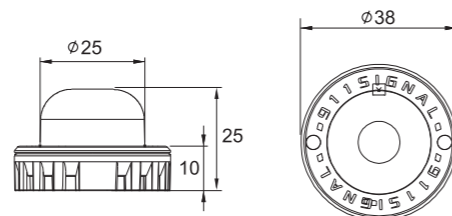

Model	Item	LED	Max Power	Voltage	Flash Patterns	Lens	Operating Temperature	Mount	Certification
ANT PRO	060601	3Pcs 3W	9W	DC 10-33V	13	TIR	-30 to +70°C	Surface Mount, Bracket mount	ECE R65 XA1 XB1
ANT6-3	060101				19	/		Surface Mount, Inside of Headlight	EMC Approved
ANT6-6	060102				22	/		Surface Mount, Inside of Headlight	EMC Approved

H1200

FEATURES

- Hard-coated lenses and aluminum housing minimize environmental damage
- 3pcs heating radiators increase heat dissipation
- Super easy installation for multiple applications
- Synchronize to other 911Signal products

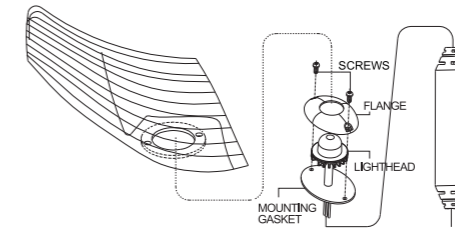

N500

FEATURES

- Tough PC lamp shade and nickel plated housing minimize environmental damage
- Extremely reliable with a lifespan over 100,000 hours
- Great as a part of a hideaway system

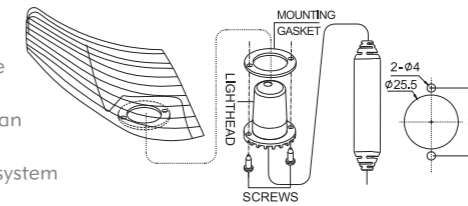

H2100

FEATURES

- Reliably provide 360° high intensity illumination through 100,000 hours lifespan
- With 3pcs of 3 Watt CREE LED on each side, the brightness far exceeds the previous generations
- Easy installation - surface mount or inside a headlamp - for multiple uses

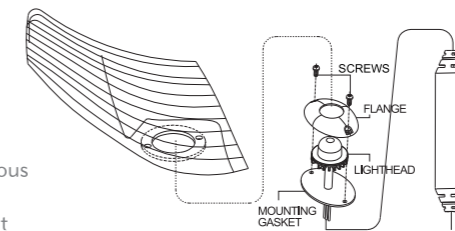

Model	Item	LED	Max Power	Voltage	Flash Patterns	Lens	Operating Temperature	Mount	Certification
H1200	060701	12pcs 3W	12W	DC 10-33V	19	/	-30 to +70°C	Surface Mount, Inside of Headlight	ECE R10
N500	060201	4pcs 3W	6W	DC 12V				Inside Head Lamp	
H2100	060301	9pcs 3W	7W	DC 12V				Surface Mount, Inside Head Lamp	

LED BEACONS

Warning System Solution

911 SIGNAL®



FD24

Our FIREDRAGON beacon is an economical and energy-saving beacon light for use atop maintenance or engineering vehicles, or on construction equipment such as trucks, bulldozers, or excavators. They can also be used on fixed plant equipment or fire, safety, or control panel alarms.

Delivering high cost-value while maintaining reliability are made possible by our closely working with supply partners. In particular, we tailored LED for this new design, while both retaining and expanding unique features.



FD24



FEATURES

- IP 68 rated, dual-protection for water resistance: seal loops in the base prevents water infiltration and discreetly placed holes dissipate any potential vapors
- Polycarbonate housing and nylon base offer sufficient protection from environmental damage
- 8 flash patterns including rotating mode
- Versatile mounting options
- Synchronize with up to 20 911Signal products

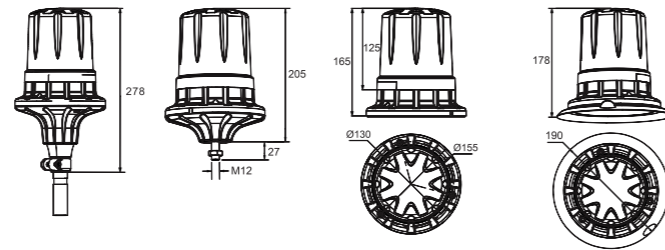

FD24 MINI



FEATURES

- IP 68 rated, excellent waterproof
- Available in amber and blue color
- A low profile design, with a height of only 1.9"
- PMMA housing and aluminum base protect the product from severe environmental damages
- 8 flash patterns including rotating mode
- 3 mounting options available: screw, suction cups and magnets (with a cigarette plug)
- Synchronization capability

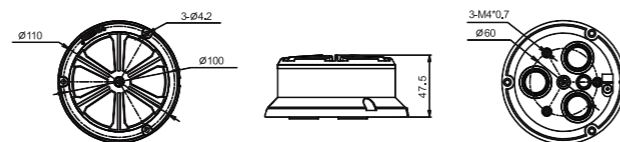

Model	Item	Max Power	LED	Lens	Flash Patterns	Voltage	Operating Temperature	Mount	Certification
FD24	080601	24W	12pcs 3W	Reflex	8	DC 10-33V	-30 to +70°C	3-Point Screw Mount, Magnetic Mount, Flexi Din Mount, Single Point Mount	ECE R65, ECE R10
FD24 MINI	080602							Screw Mount, Vacuum / Magnet Mount	

C12 MAG

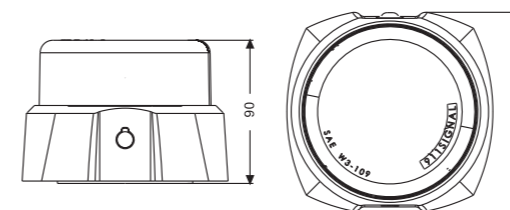

FEATURES

- Rechargeable with three UN38.3 approved Panasonic lithium batteries
- A 4-hour charge allows 8-hour duration
- DERKA approved super strong magnets utilized to stand a speed up to 232kph
- A remote control included for on/off and flash pattern selections
- Remote control is applicable within 35m from the product in open space
- A cigarette plug provided for quick installation
- 22 built-in user selective flash patterns, including 5 simulated rotating patterns

Model	Item	Max Power	LED	Lens	Flash Patterns	Voltage	Operating Temperature	Mount	Certification
C12 MAG	080408	26W	12pcs 3W	Reflex	22	DC 10-33V	-30 to +70°C	Magnetic Mount	SAE, CA Title 13 ECE R65, ECE R10

Your innovative and Reliable partner

SPOT



FEATURES

- Screw-less structure, simple and clean
- Available in amber and blue color
- IP67 rated; fully encapsulated for moisture, vibration and corrosion resistance
- Medium profile, smooth polycarbonate outer dome
- Synchronization and alternation of multiple beacons under different wiring modes
- UV-resistant PC lampshade and aluminum base facilitate heat dissipation and extend lifespan

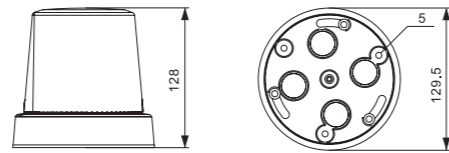

CONDUCTOR



FEATURES

- Low profile, smooth polycarbonate outer dome
- Base diameter reaches 180mm
- Fully encapsulated for moisture, vibration and corrosion resistance
- Hard-coated lenses minimize environmental damage and aluminum chassis facilitates heat dissipation

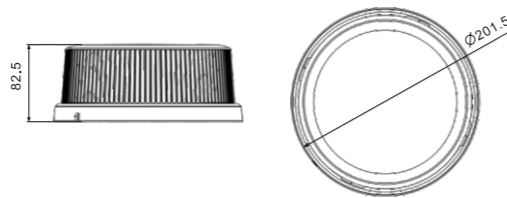

Model	Item	Max Power	Flash Patterns	LED	Voltage	Operating Temperature	Mount	Certification
SPOT	080801	26W	8	12Pcs 3W	DC 10-33V	-30 to +70°C	Magnetic Mount, Screw Mount, Pole Mount	ECE R65 TA1 TB1 ECE R10
CONDUCTOR	081001	32W	11	15Pcs 3W			9 Points Magnetic Mount Screw Mount 3 Points Magnetic Bolt Mount	SAE Class 1 ECE R65 TA2 TB1 ECE R10

LED BEACONS

C24

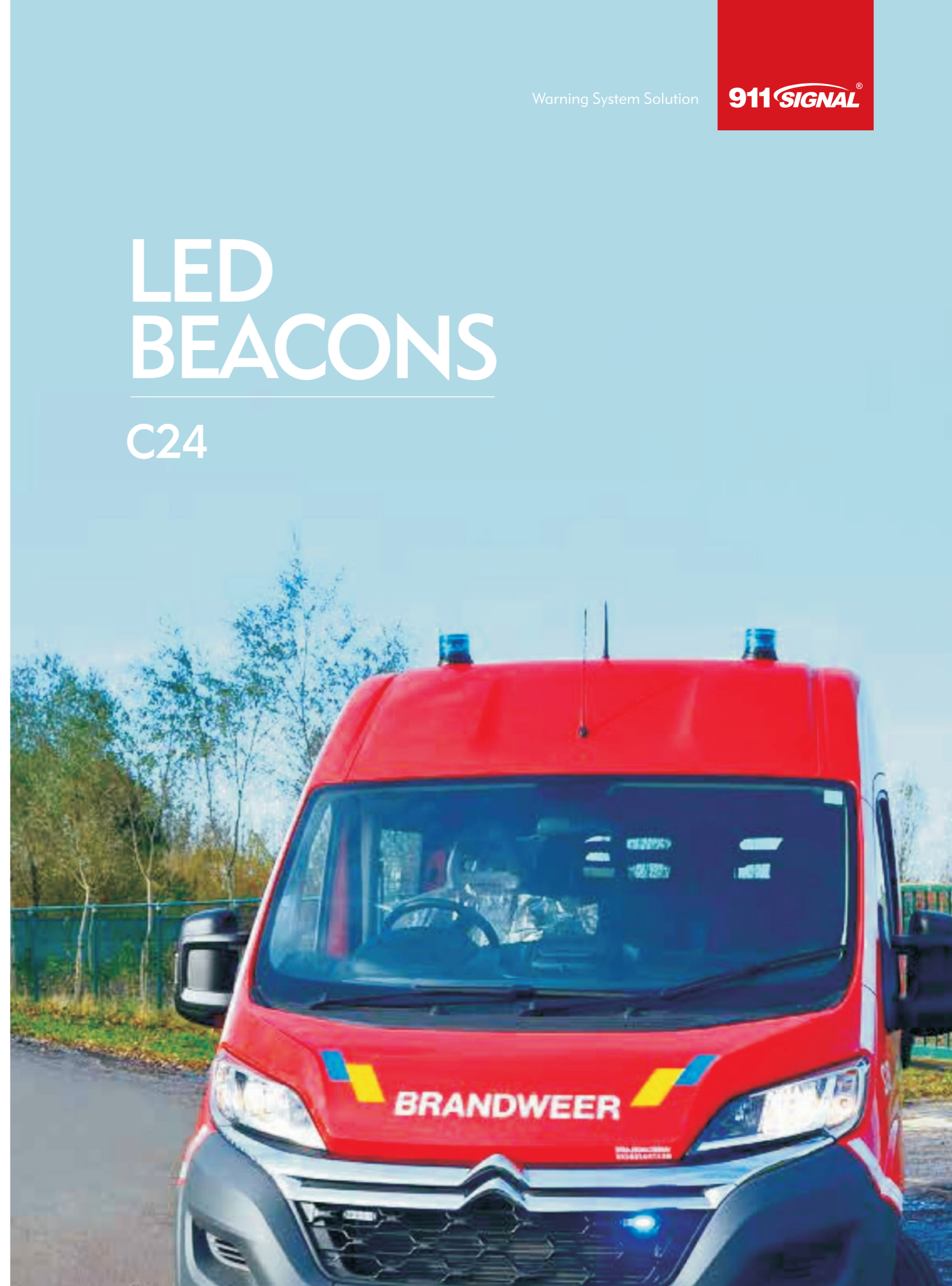

C24



FEATURES

- IP 68 rated and highly resistant to vibration and corrosion
- Available in amber and blue color
- Two levels of unique LED reflectors provide a focused signal for superior brightness
- The bottom of the strobe beacon incorporates an aluminum alloy for increased heat conduction and heat dissipation.
- Easily installed or uninstalled with permanent mount, suction cups or magnetic mount (utilizing a cigarette plug)

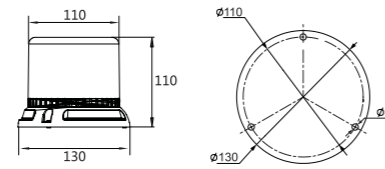

C12



FEATURES

- Available in amber and blue color
- Low amp draw and bright output provide the ideal beacon for everyday use
- IP 68 rated and highly resistant to environmental damage
- 22 Built-in user selective flash patterns, including 5 simulated rotating patterns
- Available in permanent, pipe and magnetic mount (with a cigarette plug)

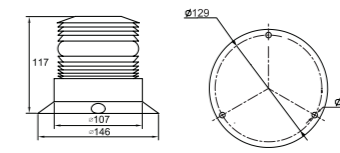

C24-E



FEATURES

- Economic version of C24 with only one level of optics
- Available in amber and blue color
- Unique Reflex optics provide superior light intensity and wide light spread, covering 360°
- IP 68 rated and highly resistant to environmental damage
- 22 Built-in user selective flash patterns, including 5 simulated rotating patterns
- Built-in permanent mount

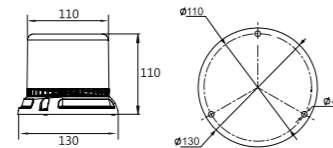

F66 / F105



FEATURES

- Cost effective with a compact design
- 360 degree visibility with 6 powerful LEDs
- Available in amber and blue
- 10 selectable flash patterns
- Quick flange mount
- Suitable for trucks, forklifts, maintenance vehicles etc
- Tough PS dome and ABS base resist environmental damage

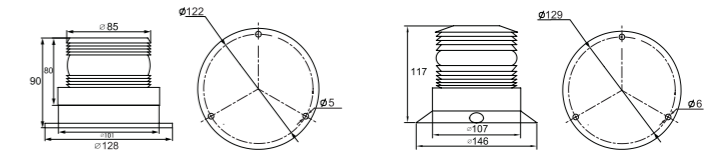

Model	Item	Max Power	LED	Lens	Flash Patterns	Voltage	Operating Temperature	Mount	Certification
C24	080102	56W	24pcs 3W	Reflex	22	DC 10-33V	-30 to +70°C	Permanent Mount, Magnetic Mount	SAE, ECE R65, ECE R10
C24-E	080104	26W	12pcs 3W						/

Model	Item	Max Power	LED	Lens	Flash Patterns	Voltage	Operating Temperature	Mount	Certification
C12	080401	26W	12pcs 3W	Reflex	22	DC 10-33V	-30 to +70°C	Permanent Mount, Magnetic Mount	ECE R65, ECE R10
F66	080505	12W	6pcs 3W	NA	10	DC 10-80V			Surface Mount
F105	080506							/	

Warning System Solution

911 SIGNAL[®]

LED STICK LIGHTS

C4-S SERIES



WASP

Your innovative and
Reliable partner

WASP

**C4-S
SERIES**

FEATURES

- Light colors and modules can be customized on demands
- IP68 rated; fully encapsulated for moisture, vibration and corrosion resistance
- Black aluminum enclosure and base ensures effective heat dissipation
- Unique Reflex optics ensures sufficient light output

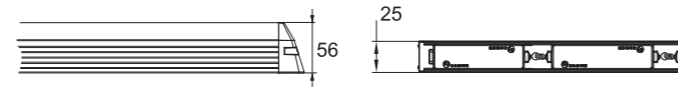

Model	Item	Length	Max Power	Flash Patterns	LED	Wire	Lens	Voltage	Operating Temperature	Mount	Certification
C4-S SERIES	040101	C4-2	9" (228mm)	21W	19	8PCS 3W	4 core Cable	REFLEX	DC 12-24V	-30 to +70°C	T-shaped Screws, Bracket Mount
	040102	C4-4	19" (482mm)	41W	26	16PCS 3W					
	040103	C4-8	36" (915mm)	87W	26	32PCS 3W	8 core Cable				
	040104	TC4-DB	36" (915mm)	87W	43	64PCS 3W					
	040501	Work light LC4	19" (482mm)	54W	Steady Burn	16PCS 3W	2 core Cable				Bracket Mount

Warning System Solution

911 SIGNAL



PIONEER™

FEATURES

- Available in single, split and dual colors
- Flexible in lengths, suitable for different vehicles for interior or exterior use
- Robust aluminum housing and hard-coated lens minimize environmental damage, making the product extremely reliable
- Reliable even in extreme weathers
- Integrated traffic direction feature with multiple flash patterns
- Easy installation with screw or bracket mount

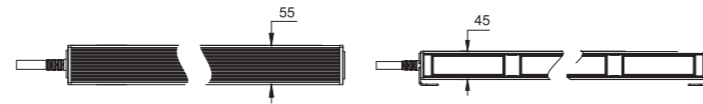

HORNET

FEATURES

- Ready to be customized in different colors and lengths according to your requirements
- Suitable for interior or exterior use
- Hard-coated lens minimize environmental damage, making the product extremely reliable
- Integrated traffic direction feature with multiple flash patterns
- Various brackets offered for mounting

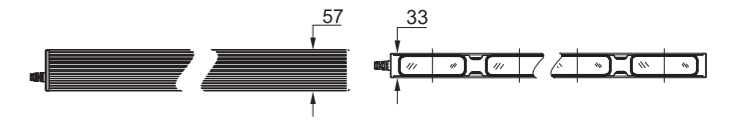

Model	Item	Length	Max Power	Flash Patterns	LED	Wire	Lens	Voltage	Operating Temperature	Mount	Certification
PIONEER	040301	PT4-2	11" (279mm)	21W	19	8PCS 3W	4 core Cable	DC 12-24V	-30 to +70°C	T-shaped Screws, Bracket Mount	ECE R10
	040302	PT4-4	22" (559mm)	42W	30	16PCS 3W					
	040303	PT4-6	33" (838mm)	62W	30	24PCS 3W					
	040304	PT4-8	44" (1117mm)	83W	30	32PCS 3W					
	040305	PL4-D8	35" (889mm)	47W	44	64PCS 3W	8 core Cable			LIN	

Model	Item	Length	Max Power	Flash Patterns	LED	Wire	Lens	Voltage	Operating Temperature	Mount	Certification
HORNET	040201	H4-2	9" (228mm)	19W	19	8PCS 3W	4 core Cable	DC 12-24V	-30 to +70°C	Bracket Mount	ECE R65 ECE R10
	040202	H4-4	18" (457mm)	37W	26	16PCS 3W					
	040203	H4-8	28" (711mm)	74W	26	32PCS 3W	8 core Cable				

LUMIOPT

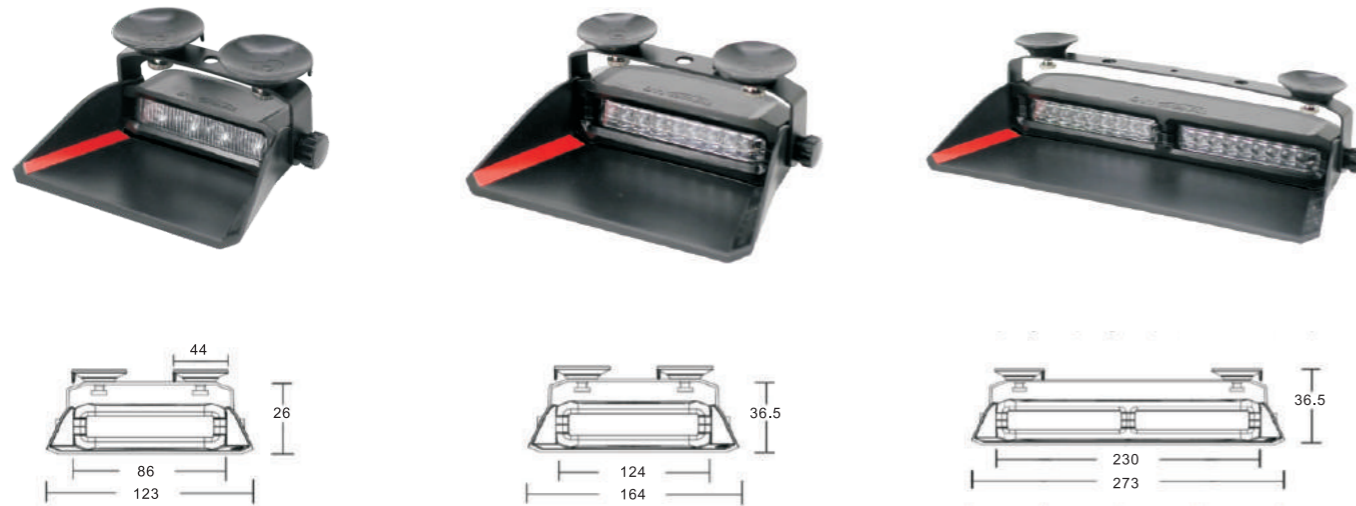

FEATURES

Lumiopt-T4/Lumiopt-X9/Lumiopt-2X9

- Glare shield is adjustable and will not block the driver's view
- Adjustable brackets, suitable for various applications
- Full encapsulated for moisture, vibration and corrosion resistance
- Hard-coated lenses and aluminum housing minimize environmental damage
- Synchronize to other 911Signal products

Lumiopt-T4

- Available in single or split color
- SMALLEST LED dash light on the market
- Cigarette plug with on/off and flash pattern switch

Lumiopt-X9

- Available in single, dual or triple colors
- Small, budget-friendly and multi-functional
- Triple-color model is supplied with a controller which provides the option to select LED colors and flash patterns

Lumiopt-2X9

- Available in single, dual or triple colors
- Multiple functions and excellent performance
- Triple-color model is supplied with a controller which provides the option to select LED colors and flash patterns

Model	Item	Max Power	LED	Lens	Flash Patterns	Voltage	Operating Temperature	Wire	Mount	Certification
ILT4	051801	6W	4pcs 3W	TIR	19	DC 10-33V	-30 to +70°C	Cigarette Plug A13-163	Vacuum Mount	SAE J595 CA T13 ECE R65 ECE R10
ILX9	051802	12W	9pcs 3W	Flare				Cigarette Plug A13-163 or Controller		
IL2X9	051803	24W	18pcs 3W							

C40

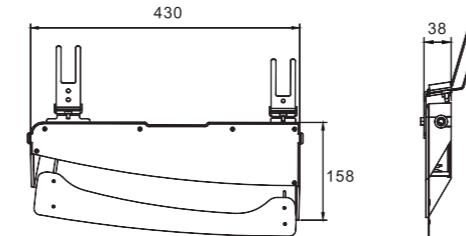

LV100

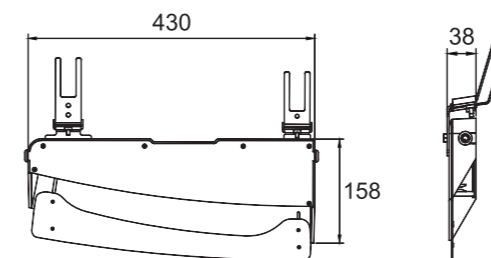

FEATURES

- Two-piece interior lightbar, perfect for slick-top, highway and undercover applications
- Aluminum alloy housing provides excellent heat dissipation
- Hard-coated lenses minimize UV damage and resist scratches
- Different mounting brackets, flexible mount on either front or rear windshield
- Multifunctional with on/off, mode, arrow light, take down etc.



FEATURES

- Three models to choose from: LV100-L6, LV100-L4 and LV100-L9 with different configurations
- Two-piece interior lightbar, perfect for slick-top, highway and undercover applications
- Aluminum alloy housing provides excellent heat dissipation
- Hard-coated lenses minimize environmental damage
- Different mounting brackets, flexible mount on either front or rear windshield



Model	Item	Max Power	LED	Lens	Flash Patterns	Voltage	Operating Temperature	Wire	Mount	Certification
C40	050301	54W	40pcs 3W	Reflex	26	DC 12-24V	-30 to +70°C	8-core cable	Bracket Mount	SAE, ECE R65, ECE R10
LV100-L9	050304	31W	90pcs 1W	LIN	28	DC 12V		3M long wire with A13-76 cigar plug		ECE R10

H2



FEATURES

- Models available: H2C4, H2H4, H2HL6
- Polycarbonate housing minimizes environmental damage and helps switch between modules
- Install with suction cups or 3M adhesive; 5 degree adjustment up or down to better fit the windshield
- High-grade heat-resistant materials are used to ensure a lifespan over 100,000 hours

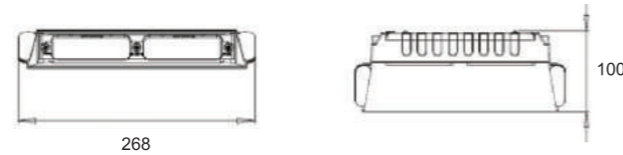

EG4



FEATURES

- Tiny and tight
- Available in single, split or dual colors
- With a strobe flash pattern and white-light illumination, EG4 features a take down function
- With the visor open, it is used to warn both pedestrians and vehicles; with visor closed, it provides interior light for reading, locating items etc.
- Aluminum alloy housing for excellent heat dissipation
- Includes Velcro mounting straps

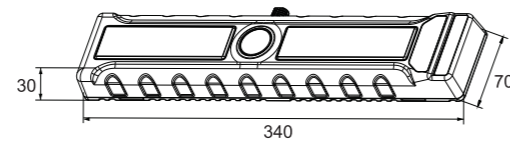

WITEL

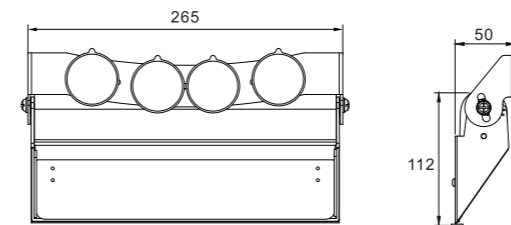

FEATURES

- Available in single, split or dual colors
- Fully encapsulated for moisture, vibration and corrosion resistance
- Strong polycarbonate housing and hard-coated lens minimize environmental damage
- Includes a cigarette plug for on/off switch and flash pattern selection
- Quickly install or remove with rubber suction cups

Model	Item	Max Power	LED	Lens	Flash Patterns	Voltage	Operating Temperature	Wire	Mount	Certification
EG4	050101	28W	3pcs 3W 8pcs 2W	TIR	19	DC 12-24V	-30 to +70°C	3M long wire with A13-76 cigar plug	Velcro Tape Mount	SAE, ECE R65, ECE R10
H2C4	050202	19W	8pcs 3W	/					Vacuum Mount, 3M Adhesive Mount	ECE R65, ECE R10

Model	Item	Max Power	LED	Lens	Flash Patterns	Voltage	Operating Temperature	Wire	Mount	Certification
WITEL-T4	050401	24W	8pcs 3W	TIR	30	DC 12V	-30 to +70°C	3M long wire with A13-55 cigar plug	Vacuum Mount	/
WITEL-L8	050402		16pcs 3W	LIN						
WITEL-5MM	050403	13W	72pcs 0.5	/						

SIREN

CJB-100AD

SR-100AD

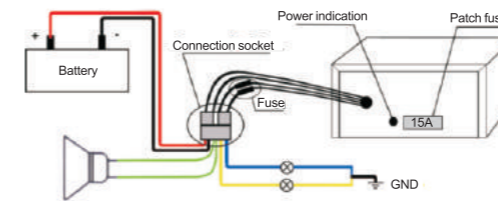

SR-100RD



Model	Item	Voltage	Power	Impedance	Sound Compression Level	Output	Tone	Accessories
SR-100AD	090801				120-130dB	2 output group Each Max 8A	Siren, Manual, Wail, Yelp, HiLow, Horn, Radio	Brackets, Fuse, Wires
SR-100RD	090701	DC 12V	100W	8Ω	116-118dB	3 output group Each Max 15A	Police, Fire Fighting, Wrecker, Project, Ambulance	15Amp Fuse, 4m 6chip data access cable Spring cable, 6chip transformer, Connect wire of speaker, Connect wire of light controller
	090702						Police, Fire Fighting, Wrecker, Project, Guest	

SIREN

IWS



IW1

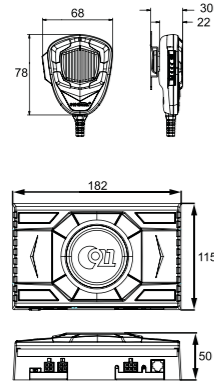

Outstanding and Economical



IW3

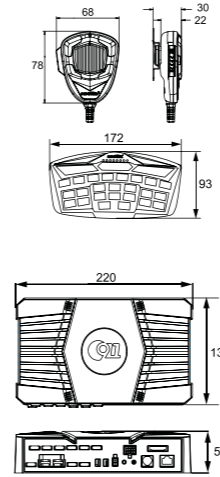

27 Operation Modes



IW2

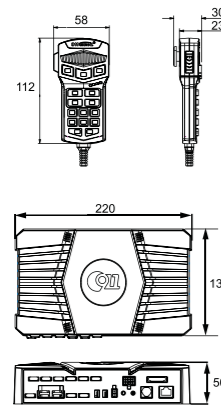

IWR: IW3+



Wireless Controller



Model	Item	Power	Impedance	Max Current Output	Voltage	Output	Tone	Certification
IW1	091001	100W	8Ω	2 output group Each Max 5A	DC 12V	300-1600Hz	Yelp, Air Horn, Manual, Wail	ECE R10
	091002						Hi/Low POL, Hi/Low SPO, Yelp, Yellp 249	
	091006						Police, Ambulance, Fire dept, Magistrate	
	091007						Air Horn, Wail, Hi/Low SPO, UMH	
	091008						HL-GEN, HL-POL, UMH, ASA	
IW2	091105			4 output group, 2 group Max 15A, 2 group Max 10A			Wail, Yelp, Piecer, Whoop, Warble, Hi/Low, Manual, Air Horn	

Model	Item	Power	Impedance	Max Current Output	Voltage	Output	Tone	Certification
IW3	091106	100W	8Ω	8 output group, 2 group Max 15A, 2 group Max 10A, 4 group Max 5A	DC 12V	300-1600Hz	Wail, Yelp, Piecer, Whoop, Warble, Hi/Low, Manual, Air Horn	ECE R10
IWR:IW3+	091071	Wireless control more than 10m						

SPEAKER

H100





H100

Suitable For Small Spaces

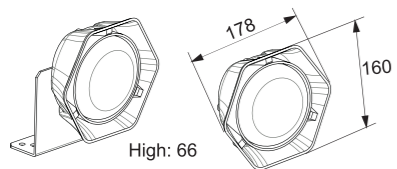

H200

Steady Sound Output Intensity of 127dB

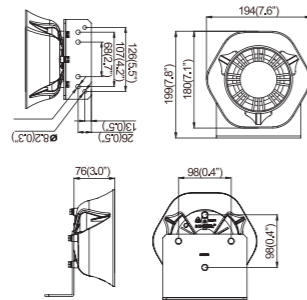

S100-3

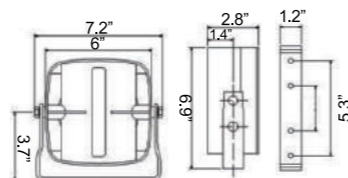

S100-3A

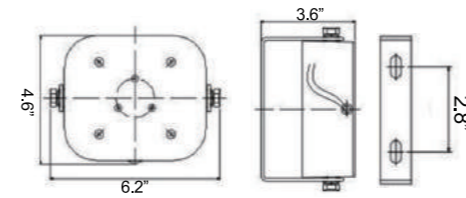

S100-1

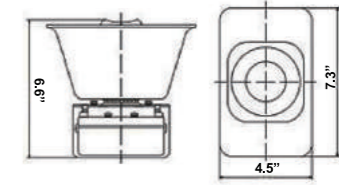

S80-1

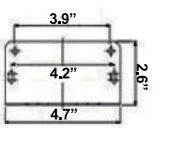

S80-3

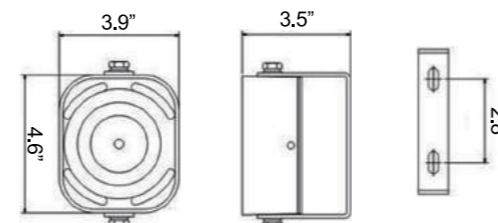

Model	Item	Power	Impedance	Frequency	Sound Distortion	Sound Intensity
H100	090101	100W	11Ω	260-4500HZ	≤5%	120-130dB
H200	090102		8Ω			127dB
S100-3	090201		8Ω	400-4000HZ		120-130dB

Model	Item	Power	Impedance	Frequency	Sound Distortion	Sound Intensity
S100-3A	090301	100W	8Ω	400-4000HZ	≤5%	120-130dB
S100-1	090601					
S80-3	090401	80W		8Ω		300-5000HZ
S80-1	090501					



SWITCH BR9000

Simple Siren and Lightbar Controllers

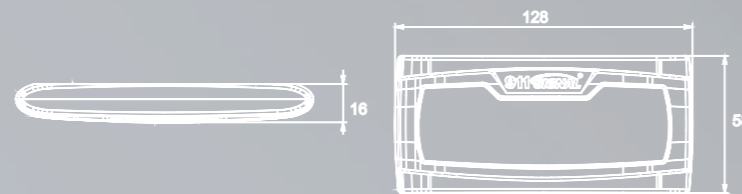

Model	Item	Voltage	Type	Output	Load	Max current	Button Lock/Unlock	Mount
BR9000	031101	DC 10-33V	Control Panel	8 Groups	NO	2mA each	1 Button Flash Pattern	360° Adjustable Bracket

FLOW

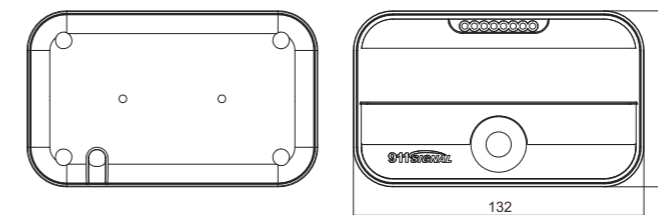
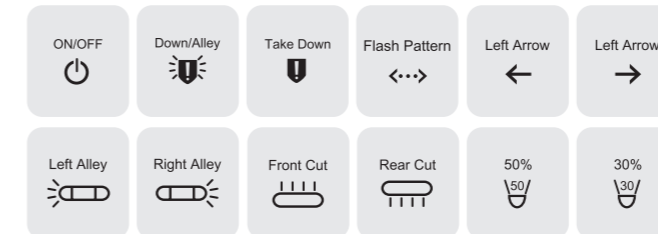

BR8

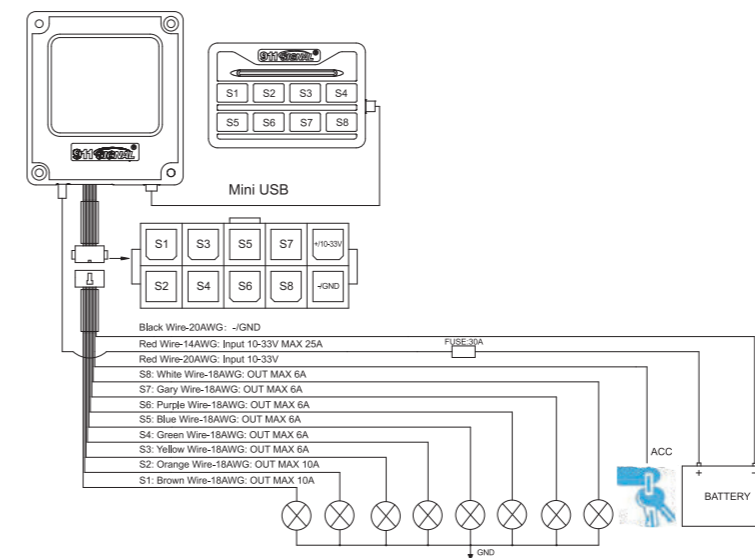

Model	Item	Voltage	Type	Output	Load	Max current	Button Lock/Unlock	Mount
FLOW	031201	DC 10-33V	Smart Switch	8 Groups	YES	100mA	/	3M Adesive, Mount Bracket
BR8	030101		Switch Panel			10A(2groups), 6A(6groups)	8 Buttons Set by Yourself	360° Adjustable Bracket

Smart Switch

BR990

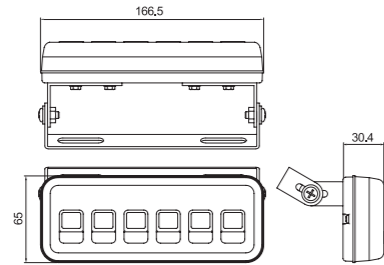

BR100

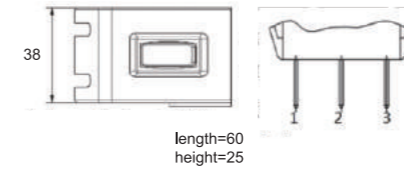

BR993

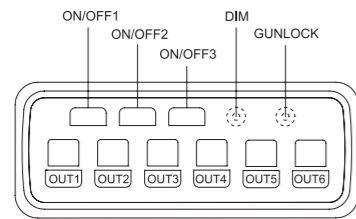

BR960

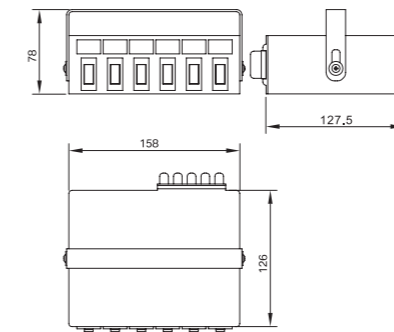

BR930

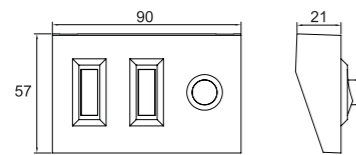

BR920

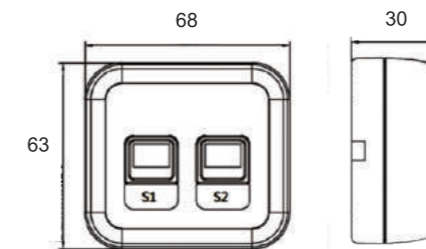

Model	Item	Voltage	Type	Output	Load	Max current	Button Lock/Unlock	Mount
BR990	030301	DC 12-30V	Switch Panel	6 Groups	YES	10A each	6 Buttons Set by Yourself	Adjustable Bracket
	030302		Control Panel		NO	2mA each		
BR993	030201		Smart Switch	8 Groups	YES	2 Group 2mA, 6 group 2A	4 Buttons 1Button 6 Buttons Set By Yourself	Adjustable Bracket
BR930	030701	/	Switch Panel	3 Groups		10A each	2 Buttons 1 Button	

Model	Item	Voltage	Type	Output	Load	Max current	Button Lock/Unlock	Mount
BR100	030601	/	Switch Panel	1 Group	YES	10A each	1 Button /	Screw
BR960	031001	DC 12V	Control Panel	6 Group		5 Groups 10A 1 Group 20A	6 Buttons /	Adjustable Bracket
BR920	030501		Switch Panel	2 Group		10A each	2 buttons for On/Off	3M Adesive

ACCESSORIES CIGAR PLUGS

A13-163

Item: 070102
FUSE: 10A



A13-E163-2N

Item: 070202
FUSE: 10A



A13-54

Item: 070301
FUSE: 8A

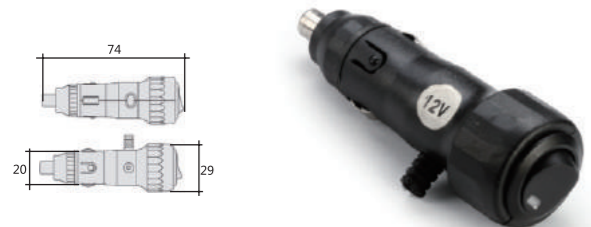

A13-102

Item: 070601
FUSE: 15A



A13-53

Item: 070401
FUSE: 10A

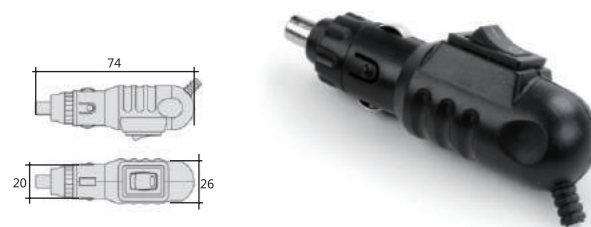

A13-76

Item: 070501
FUSE: 10A



ACCESSORIES BRACKETS

B1

Item: 100401

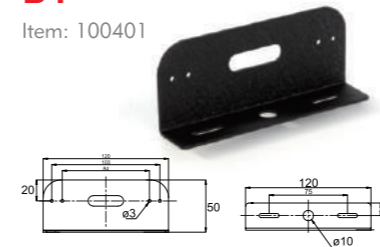

B5

Item: 100405

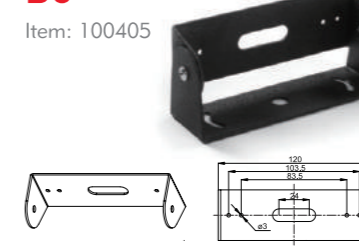

B2

Item: 100402

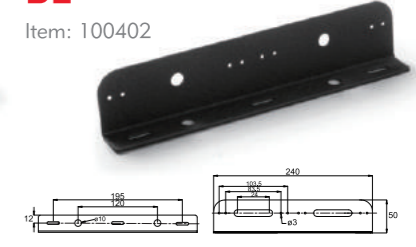

B6

Item: 100407

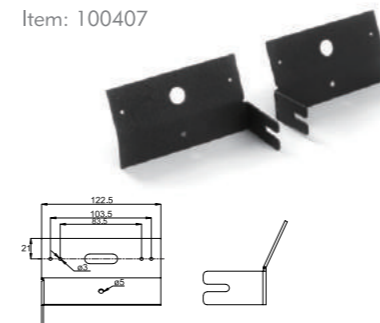

B3

Item: 100403

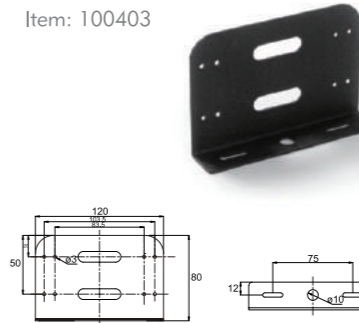

B8

Item: 100406

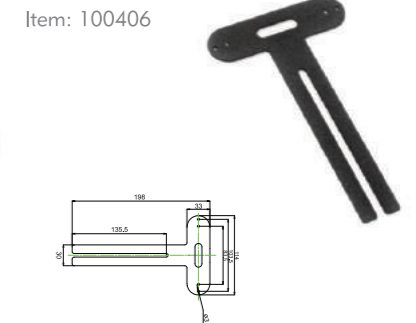

B4

Item: 100404

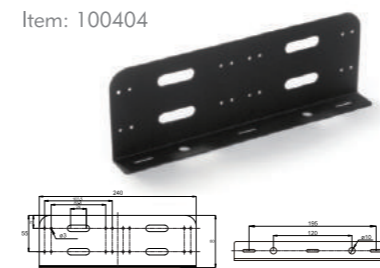

B9

Item: 100408

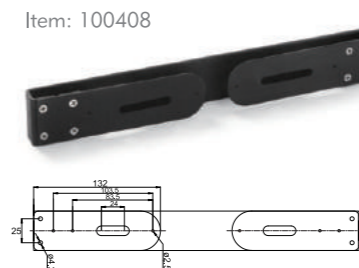

B10

Item: 100409

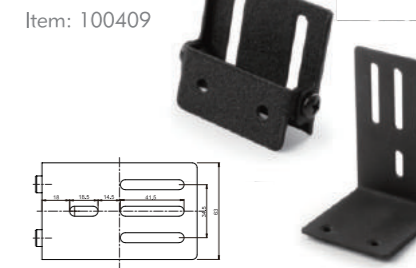

C9

Item: 100307



B11

Item: 100411



P3 & ANT6

Item: 100303



ACCESSORIES BRACKETS

MZ002

Item: 100410

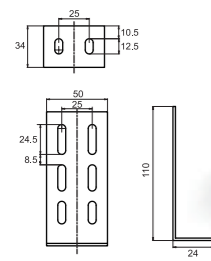

Item: 101001



Item: 101003



Item: 101005



Item: 101006



Item: 101002



Item: 101004



Item: 101101



Item: 101102



Item: 011842



ACCESSORIES FOR BEACONS

CR-01

Item: 100501

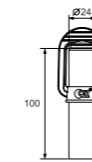

CR-02

Item: 100502

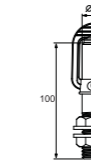

CR-03

Item: 100503

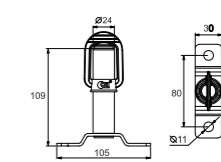

CR-04

Item: 100504

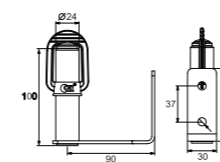

CR-05

Item: 100505

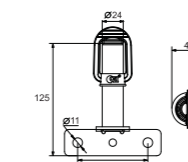

CR-06

Item: 100506

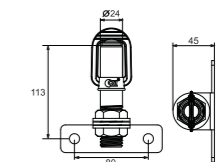

GUTTERS

MS107

Item: 100201

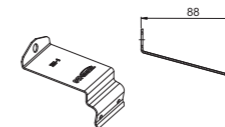

Gutter: 2 Pcs	Screw	M5x20 4 Pcs
		M8x75 2 Pcs

MS182

Item: 100202

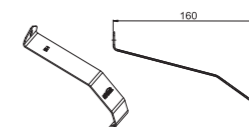

Gutter: 2 Pcs	Screw	M5x13 4 Pcs
		M8x75 2 Pcs

MS199A

Item: 100203

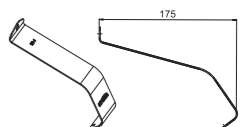

Gutter: 2 Pcs	Screw	M5x13 4 Pcs
		M8x75 2 Pcs

MS199B

Item: 100204

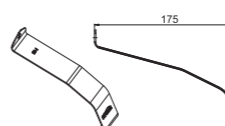

Gutter: 2 Pcs	Screw	M5x13 4 Pcs
		M8x100 2 Pcs

MS187

Item: 100205

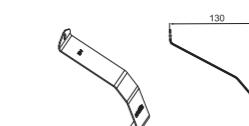

Gutter: 2 Pcs	Screw	M5x13 4 Pcs
		M8x100 2 Pcs

MS179

Item: 100206

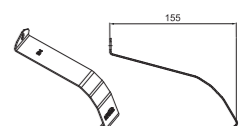

Gutter: 2 Pcs	Screw	M5x13 2 Pcs
		M8x75 2 Pcs

MS218

Item: 100207

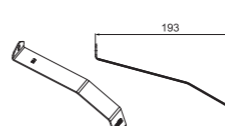

Gutter: 2 Pcs	Screw	M8x13 4 Pcs
		M8x75 2 Pcs

MS080

Item: 100208

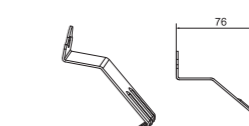

Gutter: 2 Pcs	Screw	M8x40 2 Pcs
		M8x100 2 Pcs

MS130

Item: 100209

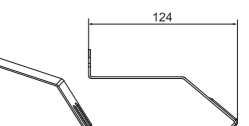

Gutter: 2 Pcs	Screw	M8x40 2 Pcs
---------------	-------	-------------

MSA210

Item: 100210

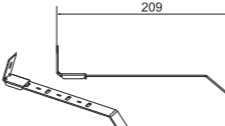

Gutter: 2 Pcs	Screw	M8x40 2 Pcs
---------------	-------	-------------



At the very beginning of July, Jack YU, 911Signal's chairman, made a trip to Essen, Germany to attend the Red Dot Design Award Ceremony. 911Signal's lightbar "Supervisor" went through a design phase lasting up 18 months, and was awarded the title "Red Dot" for its high design quality.

Red Dot Award is known to everyone from the industrial design industry, and is one of the most influential and most competitive design competition in the world. The criteria set by the jury is extremely strict. Only products launched within the past two years will be scrutinized. Contending products must distinguish themselves from their category, setting a very high bar for every designer. Therefore, the "Red Dot Label" is the widely acknowledged as an authoritative recognition on the design quality.

Among all the warning system products from across the world, 911Signal's "Supervisor" couldn't have earned the Red Dot Label without Jack and the team's toil and moil. The label also motivates and inspires 911Signal team to strive for better design in the near future.



DISCIPLINE PRODUCT

LED Lightbar IntelComm

LED Lightbar IntelComm

DESIGN

D'Andrea & Evers Design
Enter, Netherlands
911Signal
Ningbo, China

MANUFACTURER

911Signal
Ningbo, China

Jury

Werner Aisslinger | Christoph Böniger | Dave Brown | Eva Castro | Albert Chen | Poonam Choudhry |
Isabelle Dahlborg Lidström | Christoph de la Fontaine | Steven Dehollander | Sertac Ersayin |
Paul Flowers | Fritz Frenkler | Bärbel Fritz | Niklas Galler | Oliver Gerstheimer | Levi Girardi | Jaques Gramser |
Tobias Grau | Stefan Grobe | Matthias Hamann | Sascha Hanke | Stephan Hühne | Ronald Ihrig | Long J Jiao |
Claus Jepsen | Thomas Junk | Ann Kalkschmidt | Tsukamoto Kanae | Chanjoon Kim | Karen Korellis-Reuther |
Jens Korte | Henk Kosche | Markus Kreykenbohm | Michael Lanz | Kristiina Lassus | Ken Tsai Lee | Dontae Lee |
Keng-Ming Liu | Kazushige Miyake | Achim Nagel | Isabella Natter-Spets | Shrikant Nivasarkar | Andy Payne |
Fátima Pombo | Anna Salander | Annett Schaper | Susanne Schmidhuber | Zuzanna Skalska |
Brian Stephens | Robert Suk | Alex Terzariol | Martin Topel | Jeroen van Erp | Charlotte von der Lancken |
Wolfgang Wagner | Markus Wallmeyer | Thomas Willemeit | Matthias Willner